

FIELD  
HITS  
GILL

2025

**GILL**<sup>®</sup>  
ATHLETICS



OFFICIAL PARTNER

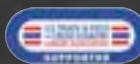

OFFICIAL TRACK & FIELD  
EQUIPMENT SUPPLIER

[GILLATHLETICS.COM](http://GILLATHLETICS.COM)

**QUALITY.  
COMMITMENT.  
INNOVATION.**

**MAKING GREAT  
EQUIPMENT  
ISN'T EASY.**

**INSTALLING  
IT SHOULD BE.**

**GILL<sup>®</sup>**  
**ATHLETICS**

*Since 1918, Gill Athletics<sup>®</sup> has been equipping coaches with innovative equipment that elevates the sport and performance of athletes across the globe.*

# WHAT'S INSIDE



**FACILITIES CHECKLIST**  
Make preparation and evaluations easier!

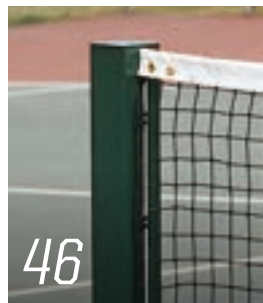
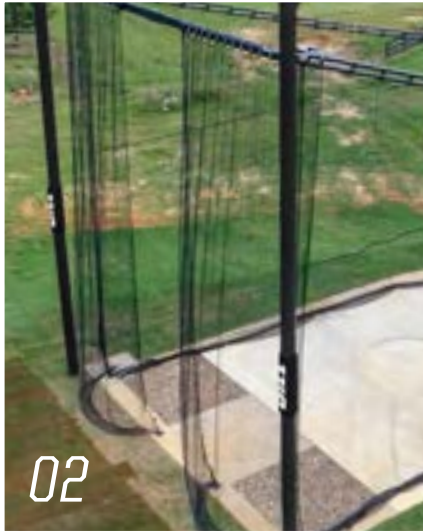

2025 Litan Sports Group, Inc. Gill Athletics, PowerMax, Pacer are all registered trademarks of Gill Athletics, Inc. Gill Essentials, Maximus, SafetyMax, AGX, Pacer One, PacerFXV, Pacer Composite, Continuum, Fusion, Carbon 1, Hollowood Star, Orbiter, OTE, Tru-Flight, T2-Fiber, Tufmesh Plus, Duralife, Track Wagon are all trademarks of Gill Athletics, Inc. NCAA is a registered trademark of The National Collegiate Athletic Association.

## CHECK OUT OUR GREAT **NEW** PRODUCTS

Featured here and online at: [www.GILLATHLETICS.com](http://www.GILLATHLETICS.com)

Prices effective from January 1, 2025 through December 31, 2025



### 02 TRACK & FIELD

- 02 Cages
- 12 Circles & Toeboards
- 14 Take-Off Boards & Track Curbing
- 16 Sand Pit Forms & Covers
- 18 Vault Boxes
- 19 Versacom Boxes & Lane Gate
- 20 Steeplechase
- 22 Raised Runways
- 23 Ballstops
- 24 Benches & Bleachers
- 26 Seating Shelters & Press Box

### 28 FOOTBALL & SOCCER

- 28 Football Goals
- 30 Football Padding & Accessories
- 32 Soccer Goals
- 36 Nets & Accessories
- 38 Anchors, Sleeves, & Field Flags

### 39 FIELD HOCKEY

- 39 Field Hockey Goals

### 40 BASEBALL

- 40 Pitcher's Mounds & Bases
- 41 Dugouts
- 42 Batting Tunnels & Cage
- 43 Foul Poles
- 44 Baseball Padding
- 45 Windscreens

### 46 TENNIS

- 46 Tennis Posts & Nets

## FEATURING

### 48 BASKETBALL

- 48 Outdoor Competition & Big Shot
- 50 Gooseneck & Vertical Post Systems

### 52 VOLLEYBALL

- 52 POWR-Sand
- 53 Recreational Outdoor Standards

At Porter Athletic, our mission is to continually improve our processes, products, expertise, and service to create superior opportunities for athletic success.

# HAMMER CAGES

Gill hammer and discus cages are engineered to protect athletes, officials, and spectators from errant throws during event competition and practices. Combined with an industry best five-year warranty, Gill Athletics partners with you to keep your facility at the top of its class.



**SAFETY.**  
**INGENUITY.**  
**LONGEVITY.**

## CUSTOMIZABLE CAGES

### Pole Color (XX)



\*To specify your color selection, use the two-digit number to replace XX in the item number.

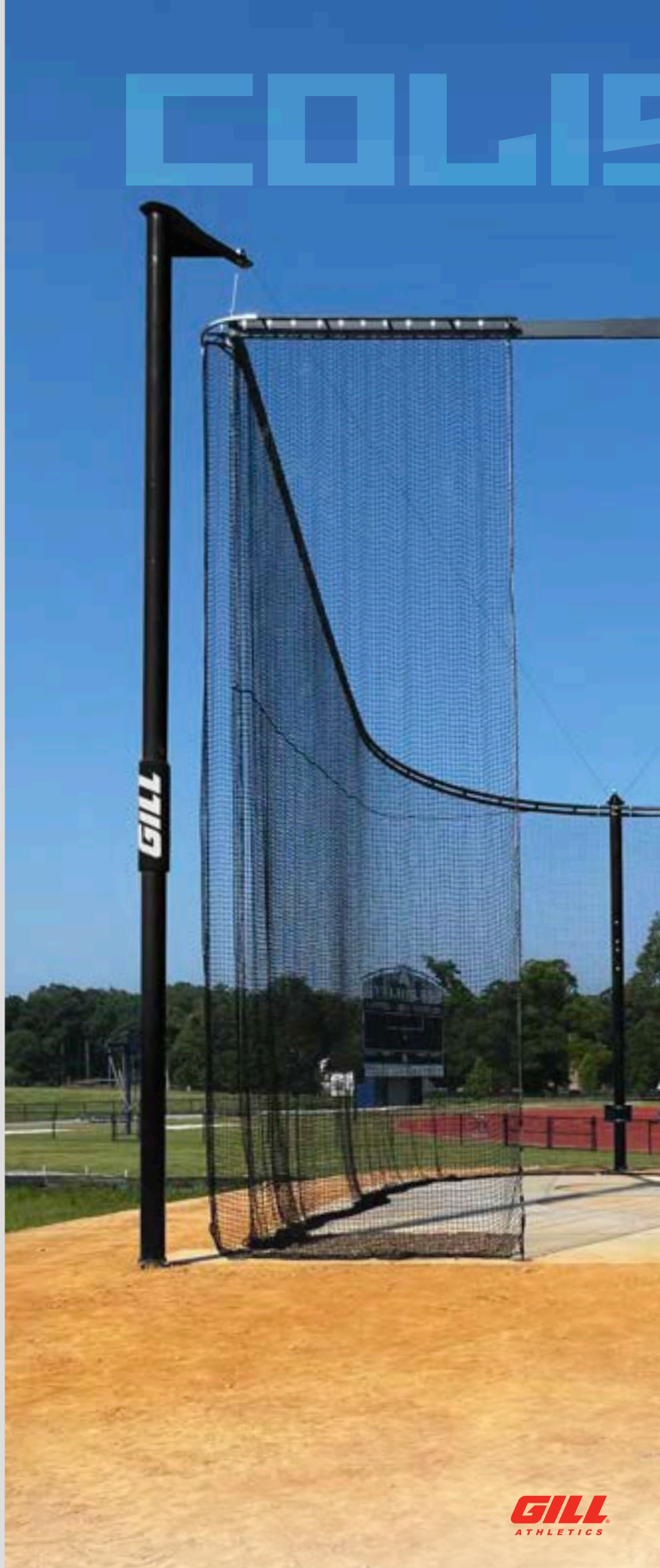

# COLISEUM



## COLISEUM HAMMER/DISCUS CAGE

753100CXXSP	Single or Double Ring	\$49900
75310092	Ground Sleeve Package	\$4460

## 3-POLE SUPER STRUCTURE

- Improved sightlines for athletes, coaches, judges and spectators
- Decreased upright post damage from high winds
- Reduced installation costs from 3-pole design and retractable door net system



## SLIDING NET DOORS

- Eliminates heavy metal door frames, reducing implement damage and dangerous wind sail
- Retractable sliding door net closure system secured by overhead magnet plate and ground anchor key below
- Competition setup is quicker and easier



Upper Magnet Plates



Ground Anchor Key

## SINGLE-OPERATOR U-NET FRAME AND WINCH

- Remove hard to reach implements and get back to the completion with ease
- Lower or raise the u-net frame in under 5 minutes with self-provided drill tool
- Exclusive winch and cable routing design engineered for single-person operation without needing heavy equipment



Winch and cable designed for single-person operation

## SINGLE OR DOUBLE RING SETUP

ONLY THE GILL COLISEUM OFFERS SINGLE OR DOUBLE RING INSTALLATION AT SAME COST, BECAUSE WE BELIEVE THAT EVERY FACILITY DESERVES TO BE ITS BEST.



OFFICIAL TRACK & FIELD EQUIPMENT SUPPLIER

# HAMMER CAGES



## CUSTOMIZABLE CAGES

See color charts on page 2 to replace the XX in the item numbers.



**BLOCK & TACKLE SAFETY PULLEY SYSTEM**



**REAR DOOR ACCESS**

KEEPS YOUR ATHLETES AWAY FROM THE THROWING SECTOR OF THE FRONT CAGE WHILE INCREASING THE SPEED OF REPETITIONS.

### NCAA HAMMER/DISCUS CAGES

- Available in single ring or double ring design
- Poles: 6063-T6 aluminum net poles
- Doors: Cages have 7m tall aluminum doors with galvanized steel door hinge poles.
- Net: Weather treated nylon 6 net with 749 lb break strength
- Cage - Main net: 20' 6"/6.25m, Door net: 23'/7m
- All cages include required cage door bracing.
- Ground sleeve kit sold separately
- Meets NCAA Specifications
- 5 Year Warranty



On all Gill Cages  
Call for Details.

#### SINGLE RING CAGE

742110	Cage	\$39755
742110CXX	Cage with Custom Color	\$43735
74211001	Ground Sleeve Kit	\$3470
732103	Optional Barrier Net (8')	\$1170

#### DOUBLE RING CAGE

742115	Cage	\$42965
742115CXX	Cage with Custom Color	\$47265
74211501	Ground Sleeve Kit	\$4260
732108	Optional Barrier Net (8')	\$1290

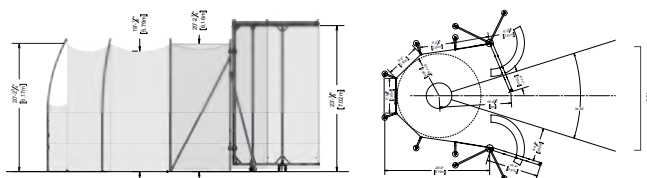

SINGLE RING CAGES

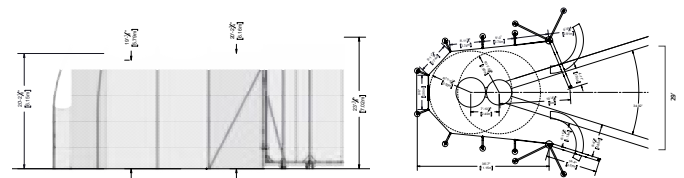

DOUBLE RING CAGES

# DISCUS CAGES



**732130**  
OPTIONAL BARRIER NET SHOWN

## NCAA ALUMINUM DISCUS CAGE

- Poles: (8) 6063-T6 aluminum net poles
- 16' 7" Net: Weather treated nylon 6 net with 340 lb break strength
- Rear door access net standard
- Rear net support tubes prevent net sag
- 18" hinged net arms secure net at all eight poles
- 36" deep ground sleeves
- **Meets NCAA specifications**
- **5 Year Warranty**

<b>732130</b>	Cage	<b>\$7635</b>
<b>732130CXX</b>	Cage with Custom Color	<b>\$9845</b>
<b>732132</b>	Optional Barrier Net (8')	<b>\$1760</b>

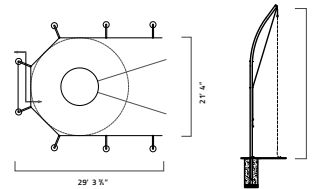

## CUSTOMIZABLE



\*To specify color with order, use the two-digit number of your color selection to replace XX in the item number.



## BRUTUS NCAA DISCUS CAGE

- For high wind areas that need extra strength discus cages
- Made of Hammer Cage strength 4" outside diameter aluminum poles
- **Meets NCAA specifications**
- **5 Year Warranty**

<b>732150</b>	Brutus Cage	<b>\$13055</b>
<b>732150CXX</b>	Brutus Cage, Custom Color	<b>\$15700</b>

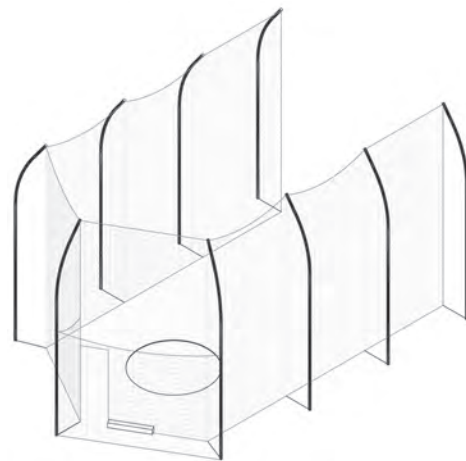

## WORLD ATHLETICS ALUMINUM DISCUS CAGE

- Poles: (9) 6063-T6 aluminum net poles
- 6m Net: Weather treated nylon 6 net with 340 lb break strength
- Rear door access net standard
- Rear net support tubes prevent net sag
- 18" hinged net arms secure net at all poles
- **Meets NCAA and World Athletics Specifications**
- **5 Year Warranty**

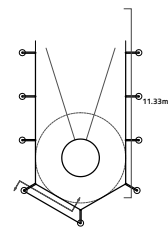

<b>732145</b>	Cage	<b>\$16885</b>
---------------	------	----------------

# HIGH SCHOOL DISCUS CAGES



REAR DOOR ACCESS



8010



On all Gill Cages  
Call for Details.

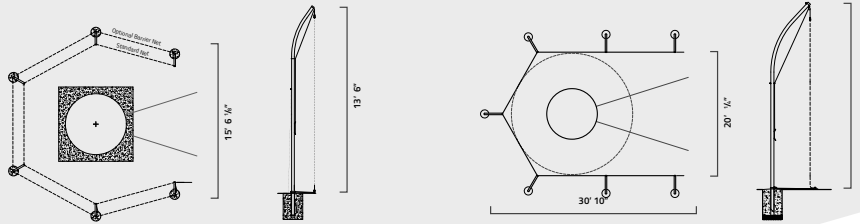

## STEEL

- Steel poles: 2 1/2" square A513 (Ultimate-42ksi, Yield-30ksi) with rolled offset for safety
- Nets: 180 lb break strength
- Net height: 13' 6"
- Meets NFHS specifications
- 5 Year Warranty

## ALUMINUM

- Aluminum poles: 2 7/8" outside diameter 6063-T6 (Ultimate-30ksi, Yield-25ksi) with rolled offset for safety
- Nets: 180 lb break strength
- Net height: 13' 6"
- Meets NFHS specifications
- 5 Year Warranty

## BRUTUS

- For high wind areas that need extra strength discus cages
- Made of Hammer Cage strength 4" outside diameter aluminum poles
- Meets NFHS specifications
- 5 Year Warranty

BEST SELLER!

6 POLE DESIGN		
STEEL	Cage	8030 \$4125
	Barrier Net	80302 \$638
ALUMINUM	Cage	8010 \$4555
	Cage with Custom Color	8010CXX \$5650
	Barrier Net	80102 \$653
BRUTUS	Cage	9010 \$8035
	Cage with Custom Color	9010CXX \$9575
	Barrier Net	90102 \$593

7 POLE DESIGN		
ALUMINUM	Cage	8020 \$5075
	Cage with Custom Color	8020CXX \$6290
	Barrier Net	80202A \$791
	Cage with Rear Door Access	8021 \$6600
BRUTUS	Cage with Rear Door Access Custom Color	8021CXX \$7685
	Barrier Net with Rear Door Access	80212 \$760
	Cage	9020 \$9350
	Cage with Custom Color	9020CXX \$10650
BRUTUS	Cage with Rear Door Access	9021 \$9910
	Cage with Rear Door Access Custom Color	9021CXX \$11215



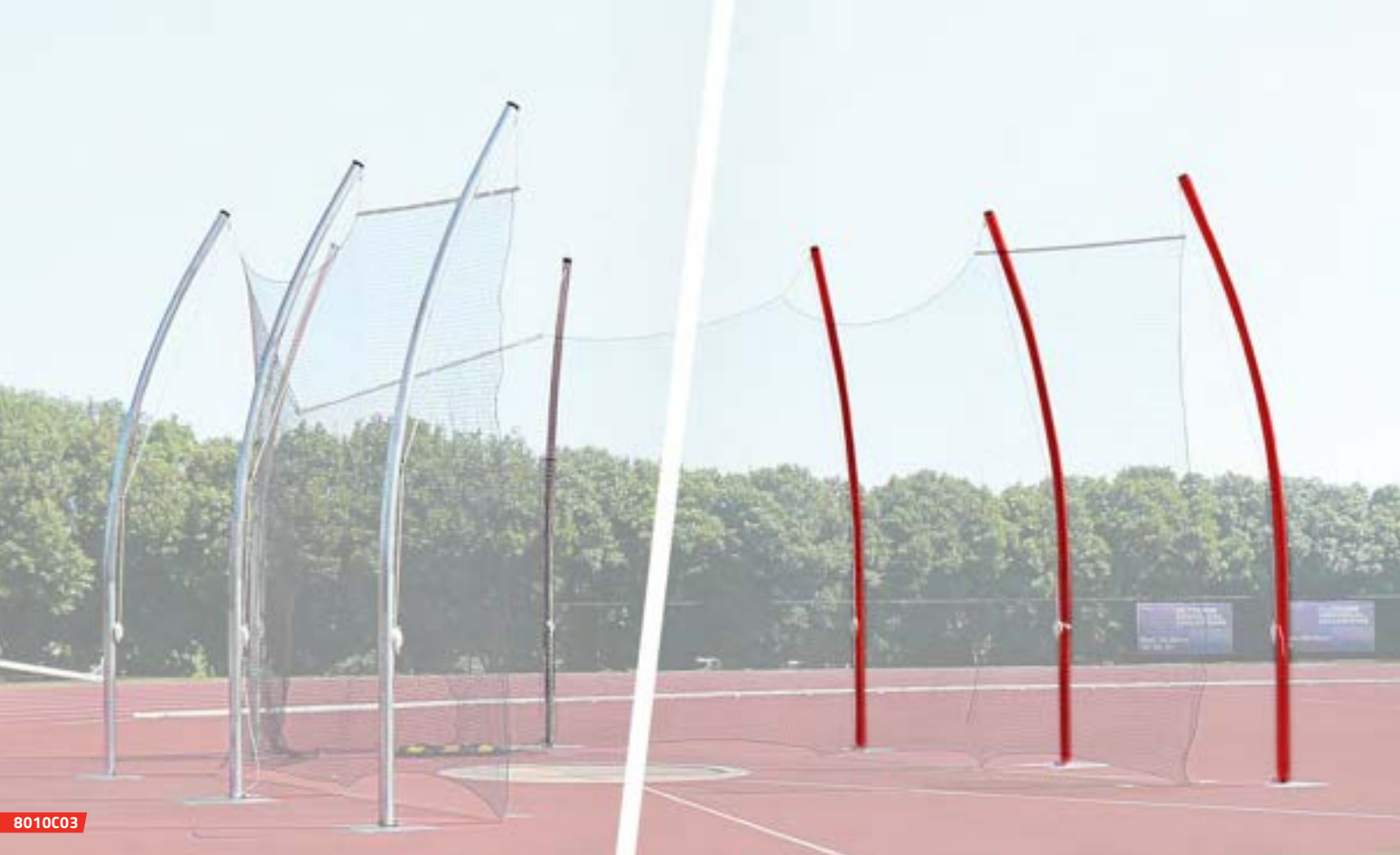

8010C03

**COLOR OPTIONS AVAILABLE!**

Show Your School Pride with Custom Powder Coating

**CUSTOMIZABLE**

- |            |            |     |       |        |             |        |          |      |        |        |       |           |             |            |
|------------|------------|-----|-------|--------|-------------|--------|----------|------|--------|--------|-------|-----------|-------------|------------|
| 01         | 02         | 03  | 04    | 05     | 06          | 07     | 08       | 09   | 10     | 11     | 12    | 13        | 14          | 15         |
| LIGHT BLUE | ROYAL BLUE | RED | WHITE | ORANGE | YELLOW GOLD | SILVER | OLD GOLD | GRAY | MAROON | PURPLE | BLACK | NAVY BLUE | KELLY GREEN | DARK GREEN |

\*To specify color with order, use the two-digit number of your color selection to replace XX in the item number.



**PRO-DOWN DISCUS CAGE**

- Poles: (6) 2 3/8" outside diameter 12 gauge steel poles
- 10' 6" Net: Knotless weather treated nylon net with 180 lb break strength
- Five galvanized steel top rungs eliminate net sag
- **Meets NFHS specifications**
- **5 Year Warranty**

**80401** Cage with Ground Sleeves **\$2620**

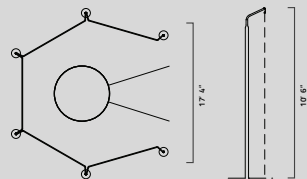

# PORTABLE CAGES



## HIGH SCHOOL PORTABLE DISCUS CAGE

- Designed for set up and removal as needed
- Poles: (6) 6063-T6 aluminum net poles
- 13' 6" Net: #504 knotless nylon netting with 180 lb break strength
- Base: A500 Grade B steel equipped with wheels. To be weighted with sand or water filled jugs.
- 5 gallon jugs with gray vinyl covers included.
- **5 Year Warranty**

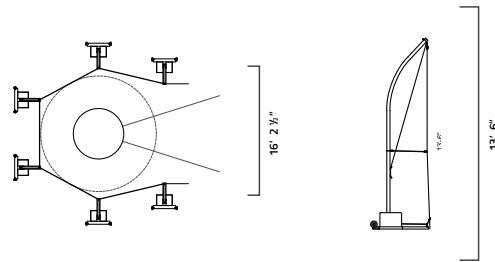

732220

\$12545

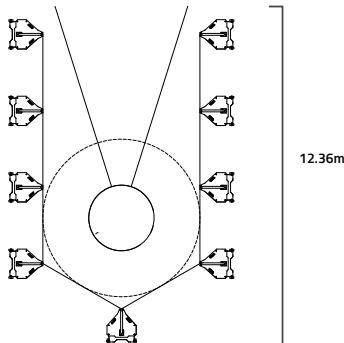

## INTERNATIONAL PORTABLE DISCUS CAGE

- Designed for set up and removal as needed
- Poles: (9) 6063-T6 aluminum net poles
- 5.1m Net: Weather treated #42A knotless net with 340 lb break strength
- Ballasted base with wheels
- **5 Year Warranty**

734240

\$29380



On all Gill Cages  
Call for Details.

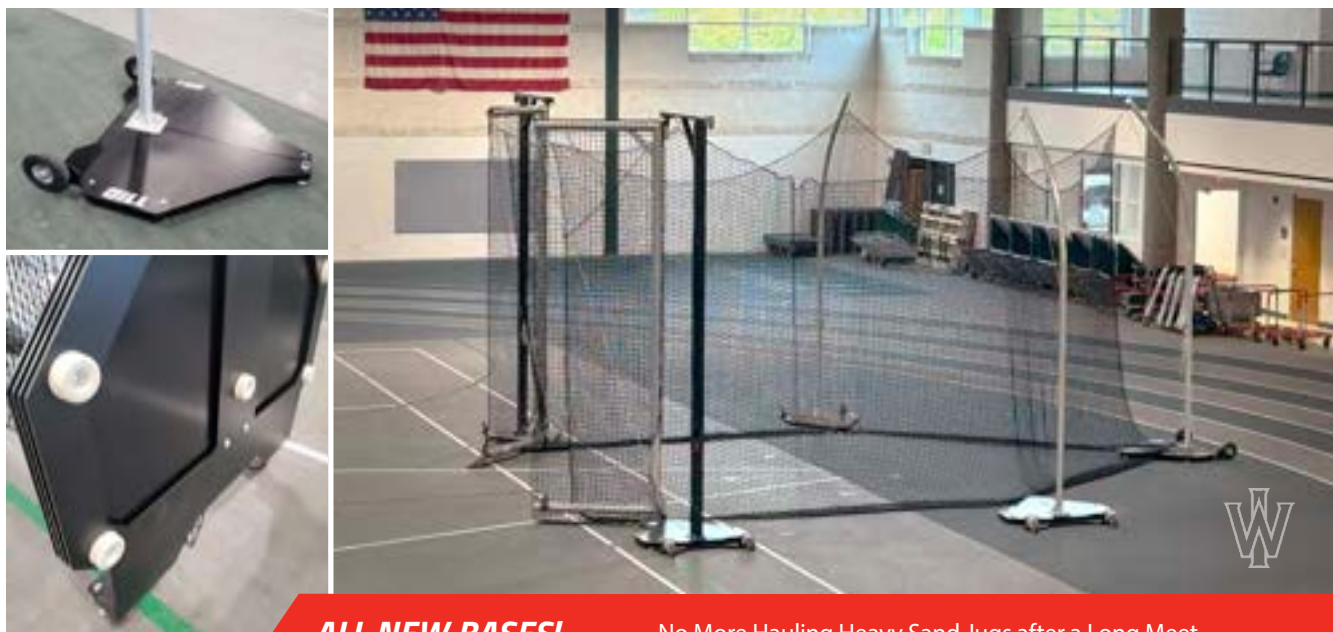

**ALL NEW BASES!**

No More Hauling Heavy Sand Jugs after a Long Meet

**NCAA PORTABLE INDOOR CAGE**

- Designed for set up and removal as needed
- 16' Doors: repositionable with wired front design for longer life
- Poles: (5) 6063-T6 aluminum net poles
- 16' Net: #42A knotless nylon netting with 561 lb break strength
- Ballasted base with wheels
- *Meets NCAA specifications*
- *5 Year Warranty*

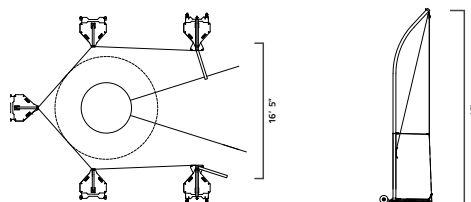

734250      \$22185

**NCAA PORTABLE DISCUS CAGE**

- Designed for set up and removal as needed
- Poles: (8) 2 1/2" outside diameter 6063-T6 aluminum net poles
- 16' 7" Net: Weather treated nylon 6 net with 340 lb break strength
- Ballasted base with wheels
- *Meets NCAA specifications*
- *5 Year Warranty*

734230      \$23305

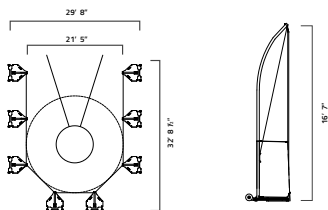

**PORTABLE SHOT CAGE**

- Designed for set up and removal as needed
- Poles: (4) 6063-T6 aluminum net poles
- 13' 6" Net: #42A knotless nylon netting with 180 lb break strength
- Ballasted base with wheels
- *5 Year Warranty*

734260      \$13185

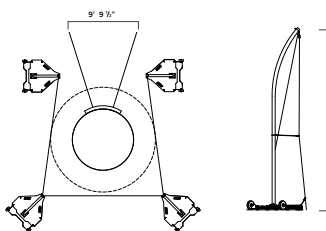

# SHOT CAGE & ACCESSORIES

## SHOT CAGE

- Poles: (4) 6063-T6 aluminum or A513 steel
- 13' 6" Net: Weather treated nylon 6 net with 180 lb break strength
- 18" hinged net arms secure net at front two poles with ground stakes used at back poles
- **5 Year Warranty**

<b>805</b>	<i>Steel Cage</i>	<b>\$3600</b>
<b>8050</b>	<i>Aluminum Cage</i>	<b>\$4355</b>

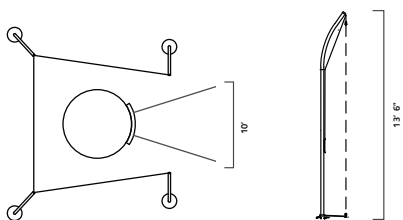

## DISCUS SECTOR NET

- Effective at stopping a discus from skipping outside of the sector
- 2' tall by 60' long 320 lb break strength discus net
- Held by 3/4" diameter steel net poles and ground stakes
- Polyethylene net spools included for convenient storage and handling

**731135**     **\$903**



## OUTDOOR THROWING NET

- Get the maximum number of reps with the minimal amount of retrieval
- Provides the perfect set up for working on throwing technique for shot put, discus and javelin (weighted balls)
- Bottom of main net has a pocket to catch implements before they hit the ground, preventing damage and making retrieval easier
- Side nets offer additional errant throw protection
- Poles: 4" diameter, 1/8" wall, T6 aluminum tube in 40" deep ground sleeves
- Nets are 749 lb test weather treated knotted nylon
- Main net is 20' x 20'

**731300**     **\$4770**



**NEW!**

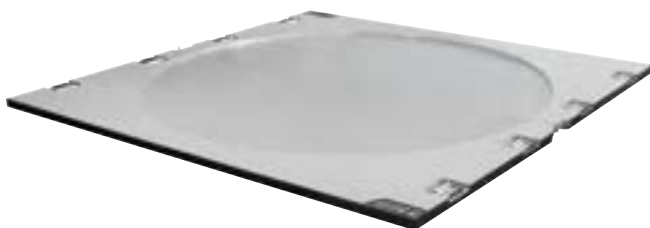

**PORTABLE DISCUS PLATFORM**

- Overall dimension of 10' x 10' x 2" constructed of two layers of 3/4" plywood and one layer of 1/2" track surface
- Two 5' x 10' interlocking sections with spring-loaded handles for ease of handling and storage
- Gray marine paint with a textured inner ring finish

3770

**\$6455**

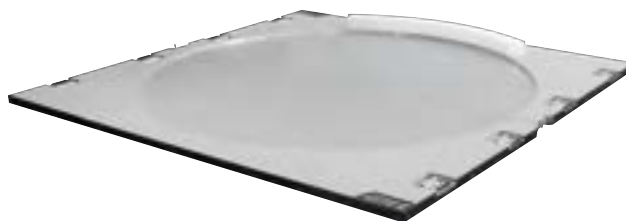

**CHAMPIONSHIP PORTABLE INDOOR SHOT/WEIGHT THROW CIRCLE**

- Overall dimension of 8' x 8' x 2" constructed of two layers of 3/4" plywood and one layer of 1/2" track surface
- Two 4' x 8' interlocking sections with spring-loaded handles for ease of handling and storage
- Gray marine paint with a textured inner ring finish
- Platform comes with easily removable Synthetic Toeboard (358) to be assembled in-field
- *Meets NFHS, NCAA and World Athletics specifications*

380

**\$5305**



*On all Gill Cages  
Call for Details.*

# CIRCLES & TOEBOARDS



**BEST SELLER!**

## ALUMINUM CIRCLES

- Four sections of 1" x 3/4" extruded aluminum angle
- Designed to be cast into concrete
- Discus circle can also be mounted to surface
- Compatible with toeboards 358, 363
- *Meets NFHS, NCAA and World Athletics specifications*

369	Shot/Hammer Circle	\$368
370	Discus Circle	\$385



## ALUMINUM CIRCLES WITH 2" ANGLE PROFILE

- Two sections of 2" x 2" extruded aluminum angle
- Designed to be cast into concrete
- Compatible with toeboards 358, 363
- *Meets NFHS, NCAA and World Athletics specifications*

374	Shot/Hammer Circle	\$875
375	Discus Circle	\$913



PROFILE FOR  
369, 370 & 372



PROFILE FOR  
371 & 373



PROFILE FOR  
374 & 375



364 with 373



## ALUMINUM SHOT CIRCLE

- Three sections of 1" x 3/4" extruded aluminum angle
- Designed to be mounted on top of concrete surface
- Anchor bolts included
- Compatible with toeboards 359, 364
- *Meets NFHS specifications*

372	\$351
-----	-------



## POWDER COATED STEEL DISCUS CIRCLE

- Three sections of 1/4" x 1 1/2" flat powder coated steel
- Designed to be mounted on top of concrete surface
- Anchor bolts included
- *Meets NFHS specifications*

371	\$661
-----	-------



**BEST SELLER!**

## POWDER COATED STEEL SHOT CIRCLE

- Four sections of 1/4" x 1 1/2" flat powder coated steel
- Designed to be mounted on top of concrete surface
- Anchor bolts included
- Compatible with toeboards 359, 364
- *Meets NFHS specifications*

373	\$458
-----	-------



## HAMMER CONVERSION CIRCLE





- Converts a discus ring into a hammer ring
- 7 interlocking sections of white PVC plastic
- *Meets NFHS, NCAA and World Athletics specifications, World Athletics certified*

3622	7 Piece System		\$627
------	----------------	---	-------



**ALUMINUM CIRCLES WITH CROSS BRACING**

- Two sections of 1/4" x 3" extruded aluminum with welded bracing
- Bolt together to maintain form during in-ground installation
- Hardware included
- Compatible with toeboards 358, 363
- Meets NFHS, NCAA and World Athletics specifications, World Athletics certified

366	Shot/Hammer Circle		\$1060
366C04	Shot/Hammer Circle; White		\$1190
367	Discus Circle		\$1055
367C04	Discus Circle; White		\$1185

**ALUMINUM CIRCLE FORMS**

- Four sections of 2" x 3" aluminum angle
- Bolt together form for in-ground installation
- Aluminum exterior bracing creates a strong frame
- Center open for smooth concrete pour and crack-resistant finish
- Inner circle is 1/4" x 3" flat aluminum bar
- Compatible with toeboards 358, 363
- Meets NFHS, NCAA and World Athletics specifications

3741	Shot/Hammer Circle Form	\$4440
3751	Discus Circle Form	\$5070

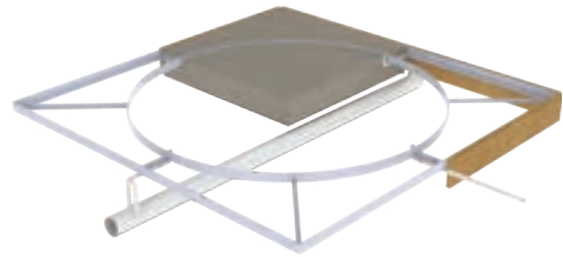

**SYNTHETIC SHOT TOEBOARD FOR DEPRESSED PAD**

- Molded low density polyethylene designed for 3/4" depressed surface
- Compatible with circles 366, 369, 374, 3741
- Meets NFHS, NCAA and World Athletics specifications

358 \$455

**SYNTHETIC SHOT TOEBOARD FOR LEVEL PAD**

- Molded low density polyethylene designed for surface mount shot circles
- Compatible with circles 372, 373
- Meets NFHS specifications

359 \$455



**ALUMINUM SHOT TOEBOARD FOR DEPRESSED PAD**

- Cast aluminum designed for a 3/4" depressed surface
- Compatible with circles 366, 369, 374, 3741
- Meets NFHS, NCAA and World Athletics specifications, World Athletics certified

363 \$741

**ALUMINUM SHOT TOEBOARD FOR LEVEL PAD**

- Cast aluminum designed for surface mount shot circles
- Compatible with circles 372, 373
- Meets NFHS specifications

364 \$741



**SYNTHETIC PLUGS**

- Keeps debris and standing water out of throwing circles
- Constructed of 3/4" thick rubber and made to fit snug inside depressed circles
- Plugs come in sections for easier handling

37001	Shot Circle Plug	\$451
37002	Discus Circle Plug	\$772



SHOWN: 368 Throw Circle (1)  
358 toeboard (1)  
All items sold separately

**INDOOR SHOT/WEIGHT THROW CIRCLE**

- Constructed of 3/4" plywood with steel hinges and handles
- Foldaway handles for easy handling and storage
- Optional three piece 3/4" 7-ply birch plywood throwing surface (sold separately, not shown)
- Compatible with toeboards 358, 359
- Meets NFHS, NCAA and World Athletics specifications

368	Indoor Shot/Weight Throw Circle	\$1700
3681	Shot Throwing Surface	\$675

# TAKE-OFF BOARDS & CURBING

## PREPARE FOR TAKE-OFF WITH GILL BOARDS



### ADJUSTABLE TAKE-OFF BOARD SYSTEMS

With the Gill Adjustable Take-Off Board Systems you get ease of installation, ease of use and dependable peak performance.

Gill Take-Off Board systems are the easiest and fastest boards to install in the market. **Complete system** comes with installation tray, adjustable folded aluminum base, reversible long lasting take-off board and foul board, and functional blanking lid ready to accept track surfacing.

- 8" take-off board and 4" foul board creates 12" system
- Exclusive easy-adjust leveling system for both horizontal and vertical axis
- Composite for longer lifespan
- Composite boards made of Polyboard®, an environmentally friendly, waterproof material that will not split or crack while offering jumpers great grip
- Meets NFHS, NCAA and World Athletics specifications

4350S	System with NCAA foul board	\$1630
4351S	System with World Athletic foul board	\$1700
4352S	System with 12" Take-Off Board	\$756
P435007	Replacement 4" NCAA Foul Board	\$134
P435107	Replacement 4" World Athletics Foul Board	\$160
P435005	Replacement 8" Take-Off Board	\$258
P435205	Replacement 12" Take-Off Board	\$246
439	1 lb Plasticine Brick - Yellow	\$15

### ADJUSTABLE 8" TAKE-OFF BOARD SYSTEMS

- Complete system: Installation tray, aluminum leveling board and reversible take-off board
- Composite for longer lifespan
- Composite boards made of Polyboard®, an environmentally friendly, waterproof material that will not split or crack while offering jumpers great grip
- Blanking lid sold separately
- Meets NFHS and NCAA specifications

### BEST SELLER!

444S	Complete Standard 8" Take-Off Board System	\$754
44405	Replacement Take-Off Board	\$368
44421	Blanking Lid Assembly	\$481







### INTERNATIONAL TRACK CURBING

- Heavy gauge aluminum design features upscale fluted dome-shaped top
- Curbing sections are notched at one end to allow easy drop in or removal of section
- Curbing supported by ½" tall ribbed feet for unencumbered drainage
- Optional pin kit available to keep curbing from shifting on track
- *Meets NFHS, NCAA and World Athletics specifications, World Athletics certified*

851A	Plain		\$17/ln ft
852P	Powder Coated		\$21/ln ft
851P	Base Pins (12)		\$257/set

### CUSTOMIZABLE

#### Powder Coat



\*Gray and Black powder coat available in Gloss or Flat



441TS

### 19.5" TAKE-OFF BOARD SYSTEM

- Complete System: Installation tray, aluminum base board, and reversible take-off board
- Composite for longer lifespan
- Composite boards made of Polyboard®, an environmentally friendly, waterproof material that will not split or crack while offering jumpers great grip
- *Meets NFHS specifications*

441TS	Complete HS System	\$809
4410S	Replacement 19 ½" Take-Off Board	\$242



### CONVERSION BOARD

- Convert a Gill 19 ½" take-off board system to an 8" system
- Includes 8" composite take-off board, black vultrax, and baseboard

441C \$503

# SAND PIT FORMS & COVERS

## Sand pit forms hold more than just sand, they hold value.

With four different options of Sand Catcher locations and two practical Sand Catcher Cover options, you can design the horizontal jump facility that will perfectly meet your needs.

No matter which combination you choose; with the Gill Functional-Form, you can rest assured it's the finest product (with the easiest installation) available.

**Choose from one of two Sand Catcher Cover systems:** traditional grate and mat or Gill (exclusive) Recessed Lid. When you consider the main function of a Sand Catcher system is not to catch sand but to store it, the Recessed Lid system is rapidly becoming the choice of facilities worldwide, as it is designed to receive track surfacing to match your track facility. When coupled with the 730148 Aluminum Sand Pit Cover, a complete logical design emerges for your world class jumps facility.

**Choose from one of four sand catcher locations:** no sides, two sides, two sides and back, or all four sides. Choosing Sand Catchers on the sides will cut unnecessary costs and eliminate potential trip hazards, providing more than ample storage space for overflow sand.

### FORM WITH RECESSED CATCHERS



### FORM WITH GRATE & MAT CATCHERS

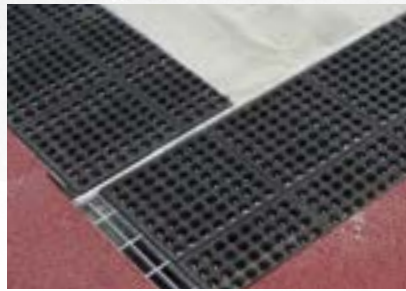

### FORM WITH NO CATCHERS



730 Perimeter Padding sold separately

4 SIDES	25' L	F46225 \$24320
	28' L	F46228 \$26370
	31' L	F46231 \$27325
3 SIDES	24' L	F46124 \$20220
	27' L	F46127 \$21180
	30' L	F46130 \$23640
2 SIDES	23' L	F46023 \$16950
	26' L	F46026 \$19415
	29' L	F46029 \$20910

4 SIDES	25' L	F44225 \$23225
	28' L	F44228 \$25960
	31' L	F44231 \$26795
3 SIDES	24' L	F44124 \$19305
	27' L	F44127 \$20220
	30' L	F44130 \$22420
2 SIDES	23' L	F44023 \$15310
	26' L	F44026 \$17085
	29' L	F44029 \$17770

LEDGE	23' L	F42023 \$6710
	26' L	F42026 \$7395
	29' L	F42029 \$7660

ALL FORMS ARE 9' 8" WIDE

FAST INSTALLATION

\*\*Track surface not included

### PERIMETER PADDING SYSTEM

- Greatly reduce possibility of injury caused by impact with sand pit edging
- Modular pads install on any sand pit quickly and conveniently
- Critical location of pads is along sides of sand pit
- Each pad is 36" long

730

\$256



### RECESSED SAND CATCHER COVER PANELS

- Designed for 1/2" (12mm) track surface
- Constructed of 1/8" aluminum sheet metal
- Standard unit measures 18" x 36" and requires a ledge around perimeter to rest on
- Special lengths available between 18" and 35" long

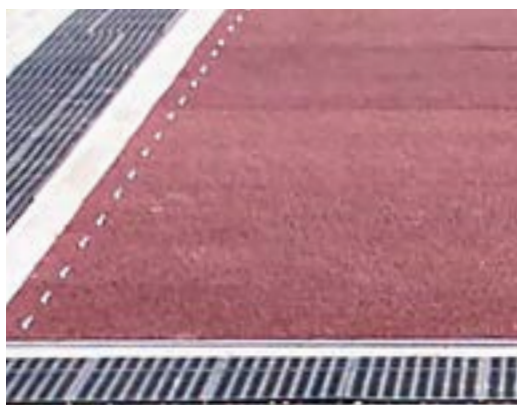

### LJ/TJ ALUMINUM SAND PIT COVER

- Each panel made from 9.5" x 1.75" x .125" aluminum planking framed with 2 3/8" x 1 1/2" x 3/16" aluminum angle
- Panels have four flush mount handles
- Recessed design for 1/2" (12mm) track surface

730148 \$52/sq ft

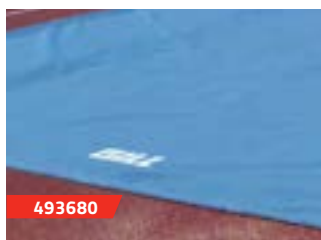

### BALLASTED LJ/TJ SAND PIT COVERS

- Exclusive Vipol Matrix mesh material or solid vinyl polyester
- Anchoring system: Vinyl wrapped galvanized steel chain perimeter
- Ballasted pit covers are custom sized and sold by the square foot (no returns)
- Optional 5' x 5' multi-color graphic available
- Dimension certification form must be submitted with order

493680	Mesh Vinyl	\$9.25/sq ft
493682	Solid Vinyl	\$9.25/sq ft
4936	Graphic Option	Call for Pricing

### COLORS



**MORE  
COLORS  
AVAILABLE!**  
Additional charge applies.

### READY-FIT ALUMINUM SAND PIT COVERS

F44023C	23' Cover	\$11030
F44124C	24' Cover	\$11525
F44225C	25' Cover	\$12025
F44026C	26' Cover	\$12470
F44127C	27' Cover	\$12970
F44228C	28' Cover	\$13465
F44029C	29' Cover	\$13905
F44130C	30' Cover	\$14400
F44231C	31' Cover	\$14895

### LJ/TJ SAND PIT COVERS

- Keep your sand pit clean and dry with solid vinyl sand pit covers or choose mesh if rain is not an issue
- Constructed of vinyl coated woven polyester
- Anchoring system: Bags filled with sand placed in pouches to weigh cover down
- Optional 5' x 5' multi-color graphic available
- Graphic worksheet and vector artwork must be provided
- Additional colors available for additional charge

730147	Gray Mesh 11' 9" x 25' 6"	\$1365
730147L	Gray Mesh 11' 9" x 31' 6"	\$1990
730147V	Gray Vinyl 11' 9" x 25' 6"	\$1590
730147VL	Gray Vinyl 11' 9" x 31' 6"	\$2065
9453	Graphic Option	Call for Pricing

# VAULT BOXES

**BEST SELLER!**

## ALUMINUM VAULT BOX

- Welded aluminum construction
- Reinforced backstop for prolonged life
- *Meets NFHS, NCAA and World Athletics specifications, World Athletics certified*

502  \$726



## ALUMINUM VAULT BOX LID

- Compatible with all Gill vault boxes
- Reinforced with two 1/2" angled vertical supports to prevent sagging
- 50201: Recessed design to accommodate 1/2" (12mm) track surface
- 50202: Flush design with no added track surface

50201	Lid-Recessed Mount	\$638
50202	Lid-Flush Mount	\$683

## STEEL VAULT BOX

- Twelve gauge steel with fold and weld construction
- Flanged edges and flared sides for secure installation
- Finished with durable white powder coat
- *Meets NFHS, NCAA and World Athletics specifications, World Athletics certified*

500  \$606

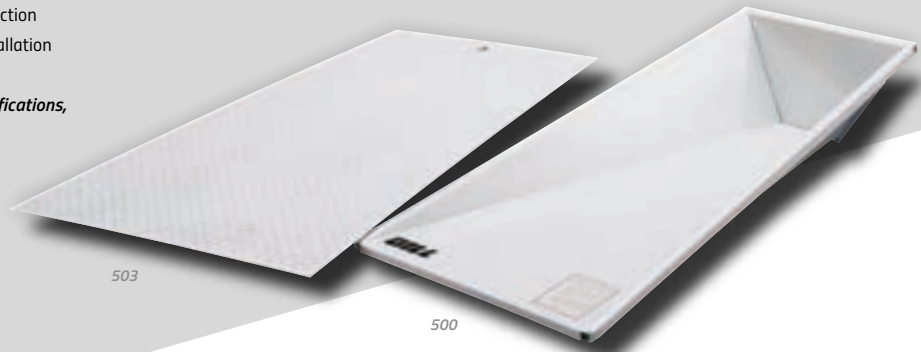

## UNIVERSAL VAULT BOX LID

- Compatible with all Gill vault boxes
- Constructed of 11 gauge hot rolled steel
- Features anti-slip designed surface
- Finished with durable white powder coat

503 \$520

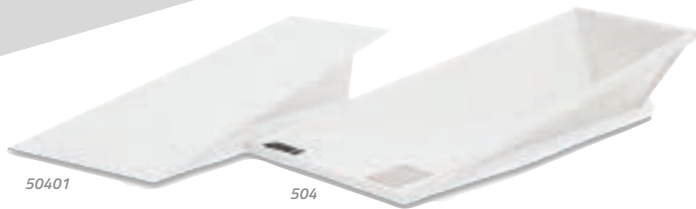

## CAST ALUMINUM VAULT BOX

- 100% cast aluminum construction with a wall thickness of 3/8"
- Standard durable white powder coat finish
- Inside corners rounded for unhindered pole rotation
- Guaranteed against cracking or warping
- *Meets NFHS, NCAA and World Athletics specifications, World Athletics certified*

505 White  \$1195



## STAINLESS STEEL VAULT BOX AND LID

- Box: Stainless steel alloy fold and weld construction for corrosion resistance
- Lid: 12 gauge 304 stainless steel plate with 2 angled vertical supports to prevent sag
- Lid: Recessed design to accommodate 1/2" (12mm) track surface
- Lid intended for use with stainless steel vault box
- *Meets NFHS and NCAA specifications*

504	Vault Box	\$1235
50401	Vault Box Lid	\$889



# VERSACOM BOXES

## CONNECTING IT ALL TOGETHER

The *VersaCom Box* provides a junction for electricity and cable hookups. This box can be put in virtually any location around performance areas of varying surfaces. The open bottom of the VersaCom Box provides adequate drainage and conduit entry, while the hand holes in the cover allow easy access.

- Divider plates in full size version, provided to help keep electrical equipment segregated
- Main box structure is made of 1/4" thick folded aluminum
- Lid is constructed of 1/4" aluminum plates for maximum support and durability

The *VersaCom Box - Synthetic Version* allows material to be bonded or poured onto the top of the lid to match the surrounding surface.

The *VersaCom Box - Turf Version* features a supplied aluminum top to allow artificial turf to be glued on the jobsite, and is tethered to the box. This top is reinforced with multiple aluminum plates for maximum strength and durability. Factory installed turf infill retainment brushes keep infill out of the box.



VERSACOM BOXES		FULL SIZE 30" L x 18" W x 14" D		HALF SIZE 15" L x 18" W x 14" D	
SYNTHETIC VERSIONS	<i>Synthetic</i>	<b>F910</b>	<b>\$1810</b>	<b>F930</b>	<b>\$1175</b>
TURF VERSION	<i>Turf</i>	<b>F960</b>	<b>\$1865</b>	<b>F970</b>	<b>\$1230</b>

### SOLD SEPARATELY

#### VERSACOM RISER

The VersaCom Riser has the same dimensions as a full-size VersaCom Box. The riser attaches to the bottom creating a box that is twice as deep.

**F90010** *Versacom Riser* **\$909**

### 3-LANE TRACK GATE

- Discourage joggers from using three inside lanes causing premature and uneven wear
- Easy lift and rotate to allow training on inside lanes
- Locks into place
- Includes ground sleeve

**8540** *3-Lane Track Gate* **\$2380**  
**010970XX** *Post Padding; Pair* **\$533**



# STEEPLECHASE

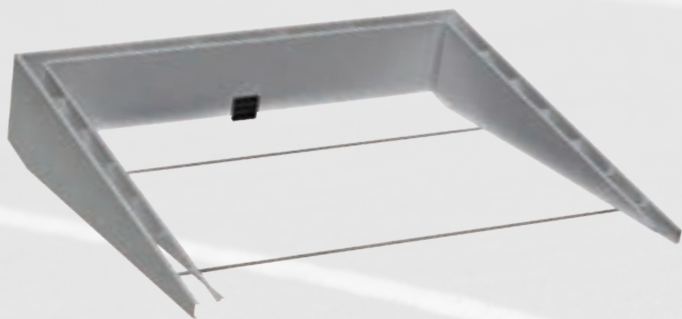

## SAVE MONEY WITH VALUEPACKS!

### VALUEPACK - SURFACE MOUNT

Package includes:

- F600 Steeplechase Water Jump Form
- 740144 Steeplechase Water Jump Barrier-surface mount version

VPF600     \$13480

### FUNCTIONAL-FORM STEEPLECHASE WATER JUMP SYSTEMS

Gill Athletics has greatly simplified the installation of steeplechase water jump reservoirs with these Functional-Form systems. With the Functional-Form, installation precision is ensured to meet NFHS, NCAA and World Athletics specifications. Structure is fabricated of specially folded 1/8" aluminum to maximize strength and includes designed inner wall supports that allow the concrete to flow through and set evenly.

- F600: Compatible with 740144 water jump barrier
- F610: Compatible with 740134 water jump barrier
- Both models compatible with 730146 aluminum water jump cover
- Both models come standard with valve option: installed front wall valve to be connected with an outgoing pipe to the drain source
- **Meets NFHS, NCAA and World Athletics specifications**

F600     Surface Mount Form     \$9445

F610     Ground Sleeve Form     \$9445

### VALUEPACK - GROUND SLEEVE

Package includes:

- F610 Steeplechase Water Jump Form with integrated ground sleeves
- 740134 Steeplechase Water Jump Barrier-ground sleeve version

VPF610     \$12885

### WATER JUMP COVERS

- Each panel made from 9.5" x 1.75" x .125" aluminum planking framed with heavy duty aluminum angle
- Panels have four flush mount handles
- Recessed design for 1/2" (12mm) track surface
- Understructure supported with 4" x 2" aluminum beams

F500C     Ready-Fit-Cover (Compatible with Gill Forms Only)     \$14085

730146     Custom Cover (Requires Field Measurements)     \$14085

### STEEPLECHASE WATER JUMP BARRIERS

- Barrier beam is 4" x 4" square steel tubing with synthetic track material
- Pull pin design makes barrier height change a snap
- Welded gusset adds needed strength support to the beam
- Adjustable to three heights: 30", 33", 36"
- Aluminum water jump barrier seal available
- **Meets NFHS, NCAA and World Athletics specifications**
- **Surface mount barrier is World Athletics certified**
- **5 Year Limited Warranty**

740134     Water Jump Barrier with Ground Sleeves     \$3665

740144     Water Jump Barrier with Surface Mount     \$4270

730150CXX     Aluminum Barrier Seal     \$1705

730150CXXSP     Aluminum Barrier Seal w/ Graphics     \$2045



F500C | 730146

### COLORS

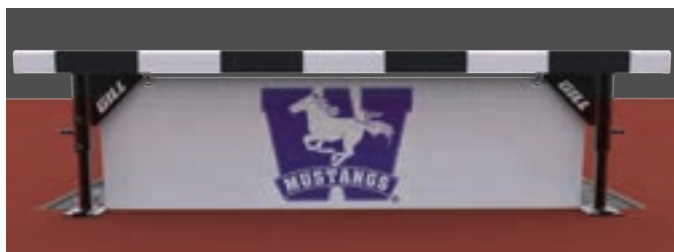

### MESH WATER JUMP BARRIER SEALS

- Add design to your steeplechase water jump
- Lightweight design will ease water barrier height change

740145204SP     White Mesh with Graphics     \$803





OFFICIAL EQUIPMENT SUPPLIER TO THE  
NCAA TRACK & FIELD CHAMPIONSHIPS

**BEST SELLER!**



### STEEPLECHASE BARRIER WITH DROP DOWN WHEELS

- 5" x 5" Barrier beam is constructed with aluminum extrusion and synthetic track material
- Wheels easily set and retract with foot engaged levers
- Pin pull design allows for simple barrier height adjustment
- Welded gusset adds needed strength support to the beam
- Adjustable to three heights: 30", 33", 36"
- Meets NFHS, NCAA and World Athletics specifications, World Athletics certified
- 5 Year Limited Warranty

740150	1 x 5m Barriers, 3 x 4m (4)		\$19990/set
740150131	4m Barrier; 13' Width		\$5050/ea
740150161	5m Barrier; 16' 5" Width		\$5495/ea





### STEEPLECHASE BARRIER

- 5" x 5" Barrier beam is constructed with aluminum extrusion and synthetic track material
- Pin pull design allows for simple barrier height adjustment
- Welded gusset adds needed strength support to the beam
- Adjustable to three heights: 30", 33", 36"
- Optional wheel kit for manual addition of wheels for transportation
- Meets NFHS, NCAA and World Athletics specifications, World Athletics certified
- 5 Year Limited Warranty



On all Steeplechase Barriers  
Call for Details.

740140	1 x 5m Barriers, 3 x 4m (4)		\$14250/set
740140131	4m Barrier; 13' Width		\$3555/ea
740140161	5m Barrier; 16' 5" Width		\$4030/ea
74014050	Wheels (4)		\$302/set



740140

### 6' TRAINING BARRIER

740140061	6' Training Steeplechase Barrier	\$2850
740150061	6' Training Barrier with Drop Down Wheels	\$4730

# RAISED RUNWAYS

In the past, these types of runway systems have been priced upwards to \$75k! You can now have this product at a fraction of that price. The Gill Raised Runway allows for the flexibility to design runways that will accommodate the pole vault, long jump and triple jump for all levels of competition and practice.

The basic unit is an 8' x 4' general runway section. Specialized sections incorporate a vault box or take-off board trays and blanking lids. The construction of each section is welded aluminum, with ½" plywood decking. Track surfacing is not included, so you can have your preference on surfacing.

Adjunct products for the Raised Runway include the Soft Shell Sand Pit Form for the long and triple jump (sand not included), and a pole vault pit elevating system.

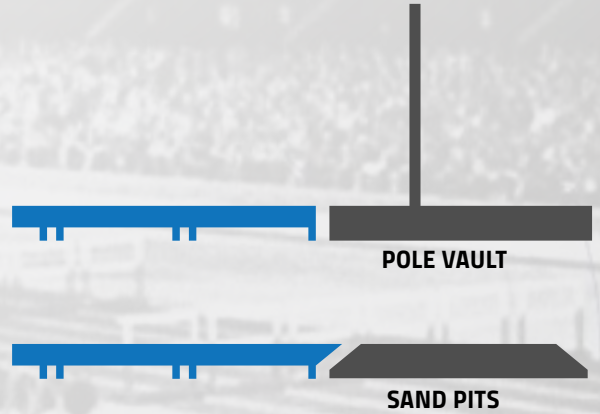

## CALL TODAY!

LET US HELP YOU PIECE TOGETHER THE **RAISED RUNWAY** SYSTEM THAT BEST FITS YOUR NEEDS.

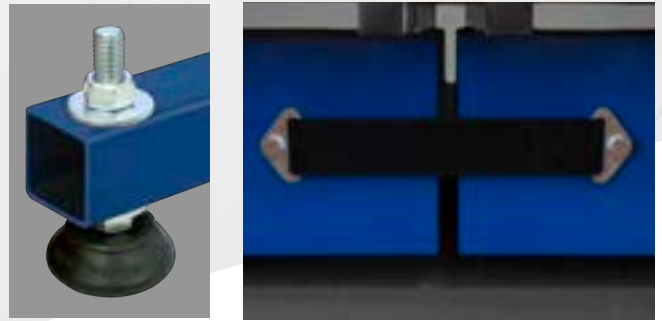

## CUSTOMIZABLE RUNWAY

### Powder Coat



\*Gray and Black powder coat available in Gloss or Flat





# BALLSTOPS

## 10' - 40' TALL BALLSTOP SYSTEMS

- 10' use 2" Sch 40 2-3/8" aluminum tube-36# Netting
- 12', 15' and 20' use 4" diameter, 1/8" wall aluminum tube - #36 Netting
- 25' and 30' use 6" Sch 40 aluminum tube - #36 Netting
- 35' and 40' use 6" Sch 40 steel tube - #36 Netting
- All Poles 10'-40' have a vertical support cable for additional net support
- Ground sleeves included
- *All poles are powder coated in architectural black*
- *5 Year Warranty*

## HERE FOR YOU!

CALL TODAY AND WE'LL HELP GET THE **BALLSTOP** SYSTEM THAT BEST FITS YOUR FACILITY.



*On all Gill Ballstops  
Call for Details.*



## BALLSTOP NET RELEASE CLIPS

Designed to drop the protective netting in high winds before any pole or hardware failure occurs.

- Marine Grade HDPE material
- Designed to break and drop nets in high winds, 20' and shorter or 25' and taller
- Sold in pack of 10 clips

**739000** 20' Ballstops and shorter **\$151**

**739001** 25' Ballstops and taller **\$151**

## PORTABLE BALLSTOP SYSTEM

The Ballstop Systems were designed to be set up and removed as needed.

- 10' use 2" Sch 40 2-3/8" aluminum tube-36# Netting
- Poles have a vertical support cable for additional net support
- The portable system uses a platform base with wheels that is weighted down by four 5 gallon jugs (included)
- *All poles are now powder coated in architectural black.*
- *5 Year Warranty*



# BENCHES & BLEACHERS



## ALUMINUM BENCHES

- Galvanized Steel Support Frames
- 10" Wide Aluminum Seat Plank
- 1'6" Seat Height

### Portable Benches

<b>72081</b>	8' Bench, Aluminum Finish	<b>\$463</b>
<b>72081CXX</b>	8' Bench, Powder Coat	<b>\$506</b>
<b>72161</b>	16' Bench, Aluminum Finish	<b>\$692</b>
<b>72161CXX</b>	16' Bench, Powder Coat	<b>\$750</b>

### Stationary Benches

<b>72082</b>	8' Bench, Aluminum Finish	<b>\$345</b>
<b>72082CXX</b>	8' Bench, Powder Coat	<b>\$379</b>
<b>72162</b>	16' Bench, Aluminum Finish	<b>\$533</b>
<b>72162CXX</b>	16' Bench, Powder Coat	<b>\$579</b>

## CUSTOMIZABLE

### Powder Coat



\*To specify color with order, use the two-digit number of your color selection to replace XX in the item number.

## ALUMINUM BENCHES WITH BACKREST

### Portable Benches

<b>74041C15</b>	4' Tennis Bench, Powder Coat	<b>\$812</b>
<b>73081</b>	8' Bench, Aluminum Finish	<b>\$708</b>
<b>73081CXX</b>	8' Bench, Powder Coat	<b>\$780</b>
<b>73161</b>	16' Bench, Aluminum Finish	<b>\$1185</b>
<b>73161CXX</b>	16' Bench, Powder Coat	<b>\$1310</b>

### Stationary Benches

<b>73082</b>	8' Bench, Aluminum Finish	<b>\$687</b>
<b>73082CXX</b>	8' Bench, Powder Coat	<b>\$748</b>
<b>73162</b>	16' Bench, Aluminum Finish	<b>\$1185</b>
<b>73162CXX</b>	16' Bench, Powder Coat	<b>\$1300</b>





**ALUMINUM STATIONARY  
OUTDOOR BLEACHERS**

- Non-Slip, Grooved Type Top Surface With Reinforcing Ribs
- 10" Wide Aluminum Alloy Planks
- Galvanized Steel Support Frames
- Plank Ends Are Fitted With Die-Cut Formed Caps

<b>381085</b>	<i>8' Long, 5 Row</i>	<b>\$2610</b>
<b>381165</b>	<i>16' Long, 5 Row</i>	<b>\$4380</b>



**ALUMINUM TIP & ROLL INDOOR BLEACHERS**

Set up seating wherever you need it. When spectator viewing space is at a minimum, the Tip & Roll seating system is a must. The hardy bleachers use the same sturdy construction as the outdoor models.

- Non-Marking 4" Swivel Casters
- Bi-Directional Model Ideal Between Two Fields
- Easy To Transport

<b>379283</b>	<i>8' Long, 3 Row</i>	<b>\$2390</b>
<b>379163</b>	<i>16' Long, 3 Row</i>	<b>\$3935</b>



# SHELTERS



OFFICIAL EQUIPMENT SUPPLIER TO THE  
NCAA TRACK & FIELD CHAMPIONSHIPS

## PORTABLE TRACK SHELTER

Steel frame is mounted on swivel casters. 360 degree seating surrounds a center storage shelf. Roof frame is constructed of aluminum bracing with architectural gray powder coat. Canopy is tensioned with a one-piece vinyl wrap. Custom color and graphic application available on canopy top.

54240CXXSP Portable Track Shelter w/ Graphics

\$6705



## CUSTOMIZABLE

Vinyl



\*To specify color with order, use the two-digit number of your color selection to replace XX in the item number.



## SCORER PRESS TOWER

- Aluminum and steel frame 7.8' x 16.3' x 11.2'
- White UV-resistant, polycarbonate top panels
- No-flat wheels with brakes for smooth mobility
- Galvanized steel tow hitch and ball coupler
- Leveling system allows for use on uneven surfaces
- Diamond plate aluminum floor and ladder rungs
- Available in 15 colors

54900CXX Scorer Press Tower \$28260



## ELITE CUSTOM SHELTER

- 7' high by 5'2" deep team shelter
- All-aluminum frame construction
- Bleacher length choice 9', 12', 15', 24'
- No-flat 12" zinc plated casters for easy mobility
- Frame available in 15 powdercoat colors
- Custom graphics available on side panels

362009CXX 9' Bench Length \$13205

362012CXX 12' Bench Length \$14735

362015CXX 15' Bench Length \$16175

362024CXX 24' Bench Length \$20345

# ***MORE THAN TRACK & FIELD***

*Your preferred source for track & field equipment is also your source for football, soccer, baseball and more.*  
**Quality. Commitment. Innovation.**

***visit us online: GillAthletics.com***



# FOOTBALL GOALS



## STEEL GOALS

4½" OD gooseneck, 3½" OD crossbar and 2¾" OD uprights.  
 8' Gooseneck allows a soccer goal to fit beneath the high school crossbar.  
 All ground sleeves and mounting plates sold separately

### HIGH SCHOOL 23' 4" BETWEEN UPRIGHTS

6' OFFSET	Ground Sleeve	Plate Mount
20' Uprights	<b>FB36120CXX</b> \$9835/pr	<b>FB46120CXX</b> \$11730/pr
8' OFFSET	Ground Sleeve	Plate Mount
20' Uprights	<b>FB38120CXX</b> \$9835/pr	<b>FB48120CXX</b> \$11730/pr

Gill football goals feature a 'No-Field Drill' installation. Both our steel and aluminum goals are engineered to decrease installation time while increasing safety no matter which you choose.

## ALUMINUM GOALS

6½" Gooseneck and crossbar with 4" diameter uprights  
 8' Gooseneck allows a soccer goal to fit beneath the crossbar  
 All ground sleeves and mounting plates sold separately

### HIGH SCHOOL 23' 4" BETWEEN UPRIGHTS

6' OFFSET	Ground Sleeve	Plate Mount
20' Uprights	<b>FB16120CXX</b> \$13620/pr	<b>FB26120CXX</b> \$15730/pr
30' Uprights	<b>FB16130CXX</b> \$14470/pr	<b>FB26130CXX</b> \$16585/pr
Spliced 30' Uprights	<b>FB16131CXX</b> \$16210/pr	<b>FB26131CXX</b> \$18370/pr
Spliced 35' Uprights	<b>FB16135CXX</b> \$16545/pr	<b>FB26135CXX</b> \$18665/pr
8' OFFSET	Ground Sleeve	Plate Mount
20' Uprights	<b>FB18120CXX</b> \$13620/pr	<b>FB28120CXX</b> \$15730/pr
30' Uprights	<b>FB18130CXX</b> \$14470/pr	<b>FB28130CXX</b> \$16585/pr
Spliced 30' Uprights	<b>FB18131CXX</b> \$16210/pr	<b>FB28131CXX</b> \$18370/pr
Spliced 35' Uprights	<b>FB18135CXX</b> \$16545/pr	<b>FB28135CXX</b> \$18665/pr

### COLLEGE 18' 6" BETWEEN UPRIGHTS

6' OFFSET	Ground Sleeve	Plate Mount
20' Uprights	<b>FB16220CXX</b> \$14010/pr	<b>FB26220CXX</b> \$16840/pr
30' Uprights	<b>FB16230CXX</b> \$14905/pr	<b>FB26230CXX</b> \$17150/pr
8' OFFSET	Ground Sleeve	Plate Mount
20' Uprights	<b>FB18220CXX</b> \$14010/pr	<b>FB28220CXX</b> \$16250/pr
30' Uprights	<b>FB18230CXX</b> \$14905/pr	<b>FB28230CXX</b> \$17150/pr

## GOAL COLORS

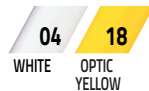

\*To specify color with order, use the two-digit number of your color selection to replace XX in the item number.



GROUND SLEEVE

MOUNTING PLATE

**GROUND SLEEVES**

Every football goal will require a ground sleeve or mounting plate for installation. All sleeves and plates are sold individually.

- F39901** For Aluminum Goals **\$529/ea**
- F39902** For Steel Goals **\$492/ea**

**MOUNTING PLATE**

- F35550** Mounting Plate **\$901/ea**

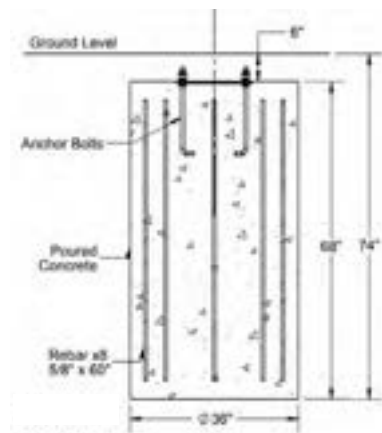
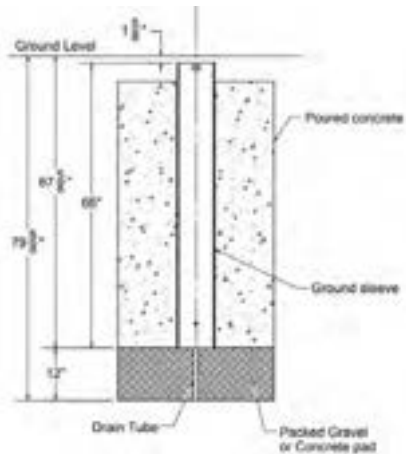

# FOOTBALL PADDING



LACE-UP PAD



DELUXE PAD



GOOSENECK PAD

## LACE-UP PAD

1½" thick polyurethane foam pad is 6' tall and fits 3½"-4½" pole diameter. Lace Closure. 20 oz vinyl available in 14 colors. Custom graphics available.

000690XX	Lace-Up Pad	\$370/ea
000690XXSP	Lace-Up Pad with Graphics	\$479/ea

## DELUXE PAD

4" thick polyurethane foam pad is 6' tall and fits 4½"-5½" pole diameter. Hook and loop closure. 20 oz vinyl available in 14 colors. Custom graphics available.

001870XX	Deluxe Pad	\$647/ea
001870XXSP	Deluxe Pad with Graphics	\$765/ea

## GOOSENECK PAD

6" thick polyurethane foam pad is 6' tall and fits 6½" pole diameter. Hook and loop closure. 20 oz vinyl available in 14 colors. Custom graphics available.

F302XX	Gooseneck Pad	\$1695/pr
F302XXSP	Gooseneck Pad with Graphics	\$1835/pr

## CUSTOMIZABLE



\*To specify color with order, use the two-digit number of your color selection to replace XX in the item number.



## FOOTBALL PYLONS

- Bottom Weighted markers (require no additional hardware to install)
- Meets NCAA & NFHS Requirements

296801	Pylons (set of 4)	\$91
--------	-------------------	------



# ACCESSORIES



## FOOTBALL STOPPER SET

This football stopper set is designed to keep fans and bystanders safe from field goals and extra points. Installed behind each football goal, the 35'h x 50'w net can be raised and lowered with ease during a game or stationary during practice. Set includes two stoppers (1 for each goal).

**F350**                      **\$13690**

## ACCESS FRAME KIT

This kit provides effortless access to the base of a football goal for easy installation, adjustment, or removal. The access frame creates a uniform, seamless surface around the goal post for improved safety. Kit includes access frame and pole plugs that fit around a goal post with a diameter up to 6 3/4". For safety, a solid plug is strongly recommended for use when the goal post is removed. Each goal post requires one kit. Blank metal allows track surface application for continuity in D-Zones.

<b>F304</b>	<i>Access Kit - Turf Covered</i>	<b>\$764</b>
<b>F3045</b>	<i>Access Kit - Blank Metal</i>	<b>\$665</b>
<b>F30410</b>	<i>Access Frame Only</i>	<b>\$460</b>
<b>F3042</b>	<i>Pole Plugs - Turf Covered</i>	<b>\$415</b>
<b>F3043</b>	<i>Pole Plugs - PVC</i>	<b>\$482</b>
<b>F3044</b>	<i>Pole Plugs - Blank Metal</i>	<b>\$241</b>
<b>F3045</b>	<i>Solid Plugs - Turf Covered</i>	<b>\$320</b>
<b>F3046</b>	<i>Solid Plugs - PVC</i>	<b>\$189</b>
<b>F3047</b>	<i>Solid Plugs - Blank Metal</i>	<b>\$289</b>

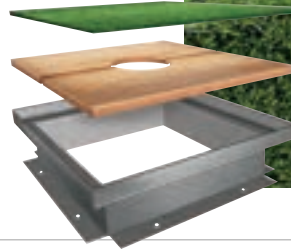
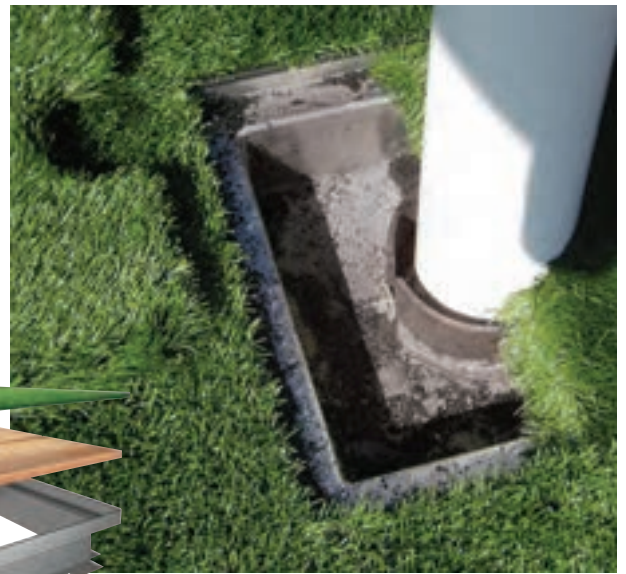

## CROSSOVER ZONE®

For everyday use, the Crossover zone is lighter and easier to handle than other conveyor belt rubber systems. Protects against steel tipped cleats, shoes and even grounds equipment wheels, yet rain drains through. Black geotextile with gold edging for safety and durability.

<b>493667</b>	<i>7.5' x 30' Zone</i>	<b>\$760</b>
<b>493668</b>	<i>7.5' x 40' Zone</i>	<b>\$908</b>
<b>493663</b>	<i>15' x 30' Zone</i>	<b>\$1080</b>
<b>493664</b>	<i>15' x 40' Zone</i>	<b>\$1310</b>
<b>493651</b>	<i>15' x 75' Zone</i>	<b>\$1980</b>
<b>493652</b>	<i>15' x 100' Zone</i>	<b>\$2380</b>
<b>493653</b>	<i>15' x 125' Zone</i>	<b>\$2945</b>

# U90 WORLD CUP & PORTABLE GOALS



upper90<sup>1</sup>

MEETS FIFA, NCAA, & NFHS

## U90 STATIONARY WORLD CUP GOAL

8' x 24' goals made of 4" round aluminum construction in a white powder coat finish.

**492200**      *World Cup Goal Package*      **\$6145**

*INCLUDED: 8' x 24' Goals (pair), White Hexagon Nets (pair), Ground Sleeves (4), Back Post Net Supports (4), Back Post Ground Sleeves (4), Net Tie Down Stakes (16)*

GET CLASSIC **WORLD CUP** STYLE ANYWHERE!



upper90<sup>™</sup>

MEETS FIFA, NCAA, & NFHS

## U90 PORTABLE WORLD CUP GOAL

Portable 8' x 24' goals made of 4" round aluminum construction that comes in a white powder coated finish with custom powder coated back posts. Goal nests under 8' football goal posts. Sold in pairs.

**493000CXX** World Cup Portable Goal Package **\$10260**

*INCLUDED: 8' x 24' Goals (pair), White Hexagon Nets (pair), 4 Easy-To-Engage Wheel Assemblies, Auger Anchor Kit, Back Bar with Weights*

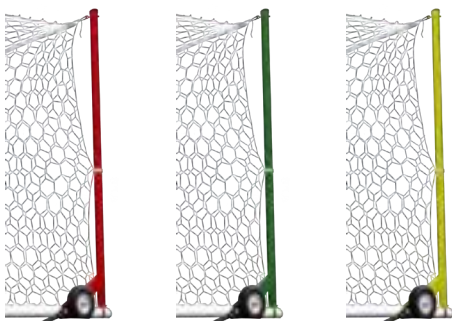

## CUSTOMIZABLE

01	02	03	04	05	06	07	08	09	10	11	12	13	14	15
LIGHT BLUE	ROYAL BLUE	RED	WHITE	ORANGE	YELLOW GOLD	SILVER	OLD GOLD	GRAY	MAROON	PURPLE	BLACK	NAVY BLUE	KELLY GREEN	DARK GREEN

*\*To specify color with order, use the two-digit number of your color selection to replace XX in the item number.*



# U90 PREMIER PORTABLE GOAL



upper90<sup>1</sup>

MEETS FIFA, NCAA, & NFHS

## U90 PREMIER PORTABLE GOAL

Portable goals made of 4" round aluminum construction that comes in a white powder coated finish. Equipped with European backstays and signature Upper90 lift and roll wheels. Nesting goal fits in front of 6' offset football goal.

<b>587200</b>	8' x 24' Premier Package	<b>\$10095</b>
<b>587202</b>	8' x 24' Premier Nesting Package	<b>\$9970</b>
<b>587203</b>	6' 6" x 18' 6" Premier Package	<b>\$9255</b>

*INCLUDED: Goals (pair), 3mm x 5" Square Braid Net / White (pair), Quick Clip Net System  
4 Easy-To-Engage Wheel Assemblies, Auger Anchor Kit, Back Bar with Weights*

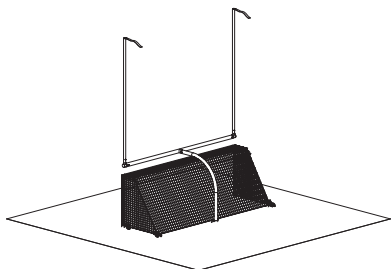

Shown with 587202 8'x24' Premier Nesting Package



# CHAMPIONSHIP & ESSENTIAL GOALS



MEETS FIFA, NCAA, & NFHS

## U90 CHAMPIONSHIP PORTABLE GOAL

Portable goals made of 4" round aluminum construction that comes in a white powder coated finish. Equipped with European backstays and signature Upper90 lift and roll wheels. A variety of net styles are available.

**48713** 8'x24' Championship Package **\$7675**  
 INCLUDED: 8' x 24' Goals (pair), Nets (pair), Transport Kit (pair) Auger Anchor Kit, Back Bar with Weights

**487200** 8' x 24' Championship Goals **\$6240/pr**  
 INCLUDED: 8' x 24' Goals (pair), Nets (pair) Auger Anchor Kit, Rear Spreader Tube Kit  
 Accessories  
**00293000** Transport Kit **\$878/ea**



# NETS & ACCESSORIES



## SQUARE NYLON BRAIDED NETTING

For use with goals with backstays

00491618	6'-6"	\$52/pr
49166186	6'-6" X 18'-6" X 6'-6"	\$200/pr
00491824	8' X 24' X 8'	\$357/pr

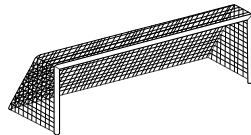

## HEXAGON NYLON BRAIDED NETTING

For use with goals with back posts

49282401	8' X 24' X 6'6"	\$581
----------	-----------------	-------

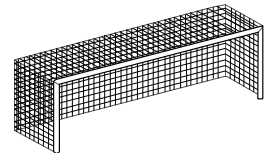

## REPLACEMENT NET ATTACHMENT CLIP

Set of 50 net clips fit any porter aluminum goal. Safe and simple clips slide into a continuous slot.

484050	\$110
--------	-------



## VELCRO® NET FASTENER

Reusable 2-sided velcro roll (15' l x 1" w). One roll fits one net to an 8' x 24' goal.

4715	\$43
------	------



## 8" SOCCER NET TIE-DOWN STAKES

Set of 8 heavy formed steel stakes. Zinc-plated material minimizes corrosion. Not to be used as goal anchors.

00418080	\$40
----------	------



**ANCHOR BAG**

Designed to anchor a soccer goal on any surface. Add your own sand and place them on the base frame of the goal. Place anchor bags in the back corners, to provide the most counter-balance.

54401 **\$28/ea**



**BACK POST NET SUPPORT**

For use stationary goals. Ground sleeve required. Back post is 2 3/8" OD steel with pulley.

00422040	Set of 4 Back Posts	<b>\$1215</b>
00402000	Ground Sleeve (1)	<b>\$215</b>



**TRANSPORT KIT**

Each kit includes two 12" diameter pneumatic wheels to easily roll any of our portable soccer goals.

00293000 **\$878**



**UPRIGHT PADS**

Round wrap around lace up pad for round soccer goals.

000690XX Round Pad **\$370/ea**



**EUROPEAN BACKSTAYS**

Backstays are 3' deep and fit the Upper90 Premier Portable goals (set of 4).

292300 **\$671**

# ANCHORS & SLEEVES

## AUGER ANCHOR KIT

Auger-type goal anchor kit (set of 4) is required on existing portable soccer goals for maximum player safety. Wraps around backstay tubing and through auger to prevent tipping.

00298170 \$231



## GOAL ANCHORING SYSTEM

Latches around the base of football goal gooseneck and connects to the rear spreader bar of goal. Simple system guards against soccer goal tip over. Compatible with 487200 Championship Goals and Aluminum Football Goals

F155 \$544/pr



## GROUND SLEEVE ANCHOR

A ground sleeve option for securing portable goals in turf fields. Featuring a small 4 1/2" footprint and a flexible top that compresses with surrounding turf on impact. Chain link wraps anchor pin inside ground sleeve and rear spreader tube on surface to secure goal in place. Padlocks included. Cap may be covered with turf for uniform appearance.

00406 \$351



## OUTDOOR GROUND SLEEVES

In-ground/sleeve style soccer goals are the best choice for providing maximum safety! Sold individually.

00402000 Fits 2 3/4" Back Posts \$215

00404000 Fits 4" Round Goals \$219



## REPLACEMENT WARNING LABELS

LABL00552000 Portable

LABL00553000 Stationary



FREE UPON REQUEST



# FIELD HOCKEY



## PRACTICE FUTSAL GOAL

Portable 6'7" x 9'10" goals made of 3" round aluminum powder coated finish. Includes 4mm white nets and easy to engage wheels. Sold as pair.

**54515**      **\$1920/pr**



## COMPETITION FIELD HOCKEY GOAL

Portable 7'H x 12'W x 4'D goals made of 2"x2" steel tubing that comes in a white powder coated finish. Includes 18" bottom boards and weather-treated 1-1/2" square mesh nets made of #21 black nylon. Meets all requirements for competition.

**260100**      **\$4600/pr**

### SOLD SEPARATELY

**260101**      Transport System (Fits 1 Goal)      **\$479/ea**

*Includes (2) pneumatic tires and support bracket assemblies. Attaches to back of a single field hockey goal so user can tip and roll the goal on and off the field.*

# BASEBALL

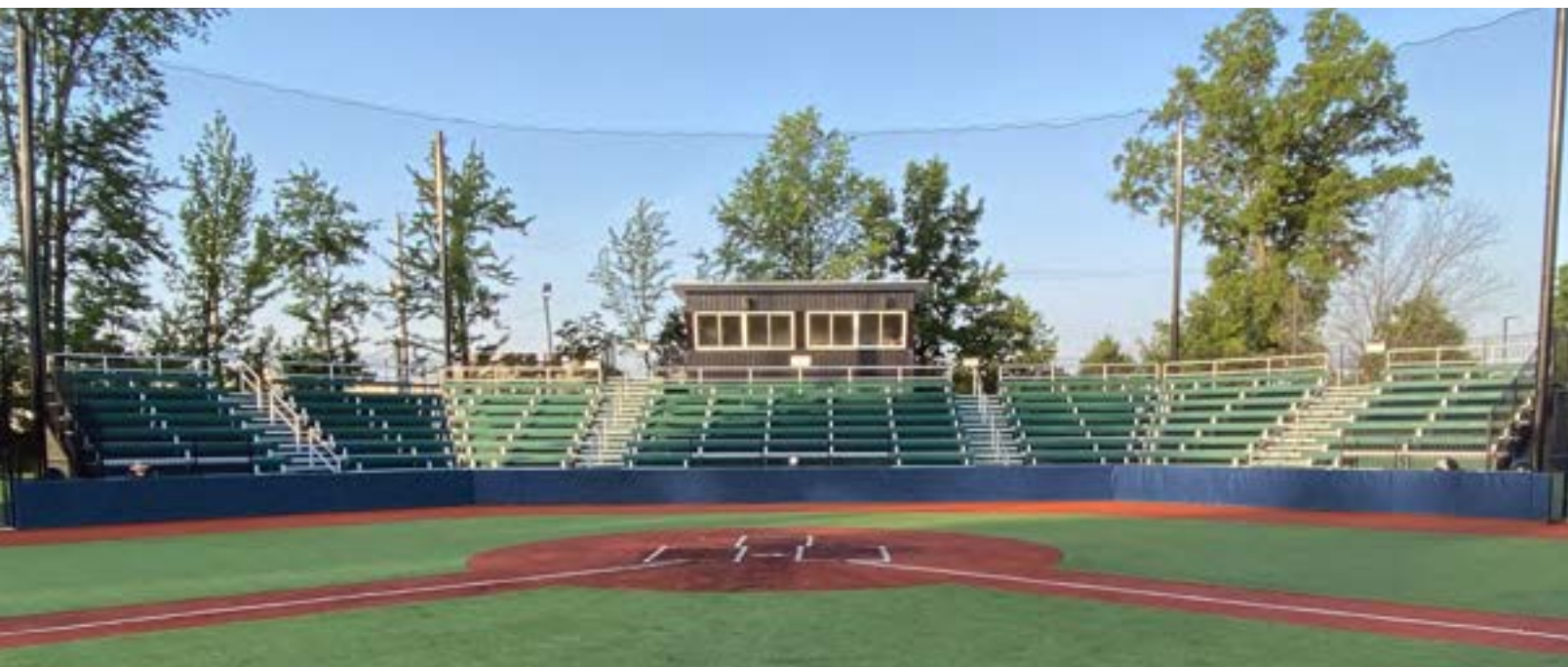

## MAJOR LEAGUE HOME PLATE

Sturdy hard rubber base designed to withstand the battering of cleats. Runners sliding into home won't dislodge the base thanks to the included anchor, while the beveled edges prevent cleats or uniforms from snagging during the slide.

33250 \$245



## MAJOR LEAGUE SHOCK ABSORBING BASES

Cushioned base designed to help reduce injury. Durable, one-piece molded rubber base with no metal parts. Removable white center post for easy storage and replacement. Does not include anchors.

33251 Set of 3 Bases \$383



## DOUBLE FIRST BASE

Helps prevent collisions and serious cleat injury. Helps umpires vision on close calls. Double anchoring sleeves/anchors for extra stability and prevents turns.

33212 \$169



## 4-WAY PITCHERS RUBBER

Molded rubber construction with inner support tubing lasts through tough games and practices. Can be periodically rotated for use over multiple seasons.

33252 Pitchers Rubber \$246



## GROUND ANCHOR SET

33254 Ground Anchors (3) \$102



## BASE PLUGS

33255 Base Plugs (3) \$54



**CANTILEVER DUGOUT**

8' tall x 8' wide cantilever dugout with 24" rear offset. Bolt together design with a 120 MPH wind rating and 50 lb/sq ft snow rating. Choose from 15 different powder coat colors. Roof only available in white.

340820CXX	20' Long	\$8215
340830CXX	30' Long	\$11660
340840CXX	40' Long	\$15125

**CUSTOMIZABLE  
DUGOUTS**

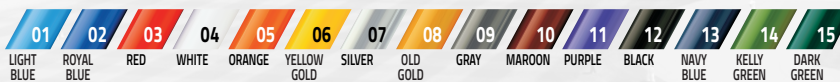

\*To specify color with order, use the two-digit number of your color selection to replace XX in the item number.

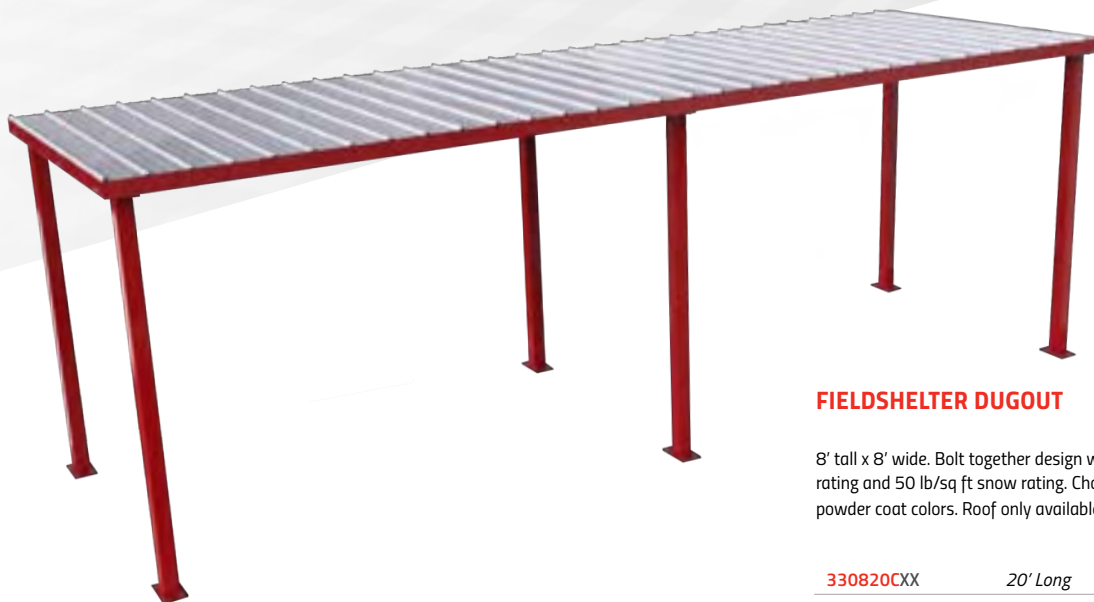

**FIELDHELTER DUGOUT**

8' tall x 8' wide. Bolt together design with a 120 MPH wind rating and 50 lb/sq ft snow rating. Choose from 15 different powder coat colors. Roof only available in white.

330820CXX	20' Long	\$6300
330830CXX	30' Long	\$8945
330840CXX	40' Long	\$11565

# BASEBALL



## BATTING TUNNELS

The open design of these batting tunnels allows the net to hang freely so balls will stop without rebound. Net supported by heavy duty 8 3/4" OD steel poles with premium architectural black powder coating. Net tensioned by 1/4" galvanized aircraft quality top cable with easy turnbuckle adjustment and snap hook net attachment. 1 3/4" square #36 weather treated knotted netting with machine sewn stitched rope borders. Features top center rib line for height control and double door entry on one end. Each tunnel 13' tall; 14' wide; 55' or 75' long.

### Single

<b>330155</b>	55' Long	<b>\$9900</b>
<b>330175</b>	75' Long	<b>\$10830</b>

### Double

<b>330255</b>	55' Long	<b>\$16245</b>
<b>330275</b>	75' Long	<b>\$17935</b>

### Triple

<b>330355</b>	55' Long	<b>\$22415</b>
<b>330375</b>	75' Long	<b>\$25200</b>



## BATTING CAGES

The cage is 10' high x 12' wide and available in either a 50' or 70' length. Netting is constructed of a durable, black UV resistant weather treated nylon with a 1 3/4", #420 square mesh. The net is supported by 2 7/8" diameter aluminum uprights to provide lightweight, yet extremely rigid supports. Rope and pulley system for easy set up without use of ladders. Install in concrete footings, outdoor, or indoor sleeves. Sleeves sold separately; 50' cage requires 8, 70' cage requires 10.

<b>330150</b>	50' Cage	<b>\$4135</b>
<b>330170</b>	70' Cage	<b>\$5375</b>
<b>802025</b>	Outdoor Ground Sleeve (1)	<b>\$61</b>

## BASEBALL FOUL POLES

Baseball foul poles extend the foul lines vertically to provide a visual indication of the fair versus foul territory. Made of two sections that bolt together in the field, constructed of heavy-duty steel pipe. Available in 5 heights, sold in pairs in a durable powder coat finish.

- 8' wing panels
- Available in optic yellow (18), white (04) and optic orange (24)
- GSMIF (ground sleeve miss installation forgiveness)

### In-Ground/Sleeved:

<b>334012CXX</b>	12', No Wings	<b>\$400/pr</b>
<b>334016CXX</b>	16', 1 Wing	<b>\$2370/pr</b>
<b>334024CXX</b>	24', 2 Wings	<b>\$6765/pr</b>
<b>334032CXX</b>	32', 3 Wings	<b>\$9955/pr</b>
<b>334040CXX</b>	40', 4 Wings	<b>\$14505/pr</b>

### Ground Sleeves

<b>00402000</b>	For 12'	<b>\$215/ea</b>
<b>F39903</b>	For 16'	<b>\$344/ea</b>
<b>F39902</b>	For 24'	<b>\$492/ea</b>
<b>F39901</b>	For 32'	<b>\$529/ea</b>
<b>F39901</b>	For 40'	<b>\$529/ea</b>

### Surface Mount

<b>334116CXX</b>	16', 1 Wing	<b>\$3665/pr</b>
<b>334124CXX</b>	24', 2 Wing	<b>\$8005/pr</b>
<b>334132CXX</b>	32', 3 Wings	<b>\$11435/pr</b>
<b>334140CXX</b>	40', 4 Wings	<b>\$16075/pr</b>



\*To specify color with order, use the two-digit number of your color selection to replace XX in the item number.

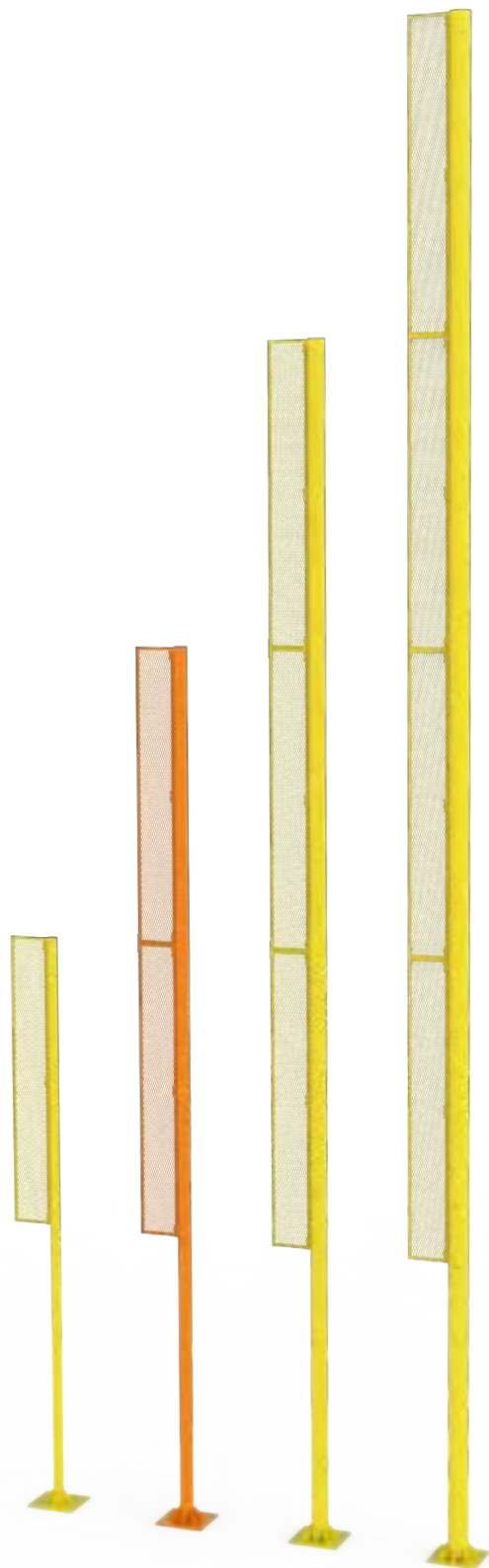
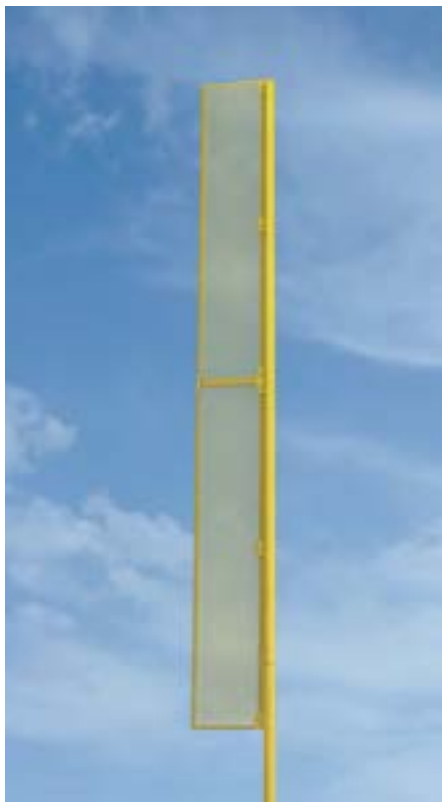

# OUTDOOR PADDING



Custom Graphics Available for Essentials and Elite Pads (Additional Charge) Add SP to end of item #

## ESSENTIALS OUTDOOR WALL & FENCE PADS

2" thick polyurethane foam core attached to 1/2" thick, sealed, water resistant PVC. Pad meets the minimum ASTM F2440 impact standard specification. Each panel uses 20oz UV treated vinyl. **WALL PAD** panels have an unwrapped back. **FENCE PAD** panels are completely wrapped, using threaded wood inserts to allow for chain link fence attachment. All pads can also be installed using "Z" clips allowing seasonal removal, repair, or replacement. All Pads built to your specified dimensions with a maximum width of 4'. Custom Graphics available (add SP to end of item #).

WALL PADS	FENCE PADS		
36202XX	36402XX	4' x 2' Pad	\$211
9036202XX	9036402XX	Custom Size - 4' x 2' or less	\$224
36204XX	36404XX	4' x 4' Pad	\$349
9036204XX	9036404XX	Custom Size - 4' x 4' or less	\$387
36206XX	36406XX	4' x 6' Pad	\$553
9036206XX	9036406XX	Custom Size - 4' x 6' or less	\$610
36208XX	36408XX	4' x 8' Pad	\$616
9036208XX	9036408XX	Custom Size - 4' x 8' or less	\$679

### Essentials Vinyl

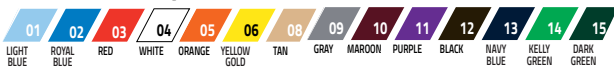

Use the two-digit number of your color selection to replace XX in the item number.

### PADDING ATTACH CLIPS

347100	6' Wall Attachment Z-Clip	\$21
3650	Under 4'x6' Fence Attachment Clip	\$70
3651	Over 4'x6' Fence Attachment Clip	\$100

## ELITE OUTDOOR WALL & FENCE PADS

3" thick polyurethane foam core attached to 1/2" thick, sealed, water resistant PVC. Pad meets the minimum ASTM F2440 impact standard specification. Each panel uses 19oz UV treated vinyl. **WALL PAD** panels have an unwrapped back. **FENCE PAD** panels are completely wrapped, using threaded wood inserts to allow for chain link fence attachment. All pads can also be installed using "Z" clips allowing seasonal removal, repair, or replacement. All Pads built to your specified dimensions with a maximum width of 4'. Custom Graphics available (add SP to end of item #).

WALL PADS	FENCE PADS		
36302XX	36502XX	4' x 2' Pad	\$270
9036302XX	9036502XX	Custom Size - 4' x 2' or less	\$305
36304XX	36504XX	4' x 4' Pad	\$434
9036304XX	9036504XX	Custom Size - 4' x 4' or less	\$482
36306XX	36506XX	4' x 6' Pad	\$670
9036306XX	9036506XX	Custom Size - 4' x 6' or less	\$738
36308XX	36508XX	4' x 8' Pad	\$762
9036308XX	9036508XX	Custom Size - 4' x 8' or less	\$839

### Elite Vinyl

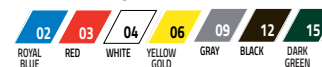

Use the two-digit number of your color selection to replace XX in the item number.

# WINDSCREENS



## TUFFY® WINDSCREENS

Screens are made with an exclusive durable mesh fabric of tightly woven micro-fibers: it's virtually tear-proof. Tuffy® is the only windscreen finished with double-needle lock stitching, eliminating the thread unraveling problem of traditional windscreens. Includes 5 year warranty, available in 20 colors. Grommets every 12". 78% Shading. Custom Printing available - call for details.

912015	Tuffy® 5' Windscreen, Per Linear Foot	\$7.50/ln ft
912016	Tuffy® 6' Windscreen, Per Linear Foot	\$8.00/ln ft
912019	Tuffy® 9' Windscreen, Per Linear Foot	\$15.00/ln ft



## RAIL PADDING

8' long pads are polyethylene foam with colored vinyl coating. UV, weather and rot resistant pads are pre-slit for easy installation. Fits over any 2 1/8" diameter or less pipe.

35912	Black	\$75
-------	-------	------

# TENNIS



## ESSENTIALS TENNIS POSTS

Competition tennis posts with fully enclosed net tensioning mechanism. Outdoor system includes ground sleeves. Indoor system requires purchase of floor sleeves. 3.5" OD high strength steel posts with heavy duty dark green outdoor powder coating. Net and accessories are sold separately.

<b>884</b>	<i>Outdoor Posts</i>	<b>\$697/pr</b>
<b>884A</b>	<i>Indoor Posts</i>	<b>\$665/pr</b>

## ELITE TENNIS POSTS

Competition tennis posts with fully enclosed net tensioning mechanism. 4" square high strength aluminum posts with heavy duty outdoor powder coating. Post cap with tamper resistant hardware to prevent vandalism or use by unauthorized individuals. Includes one winch post and one tie-off post. Ground sleeves, net, and accessories all sold separately.

<b>885</b>	<i>Dark Green Posts</i>	<b>\$1055/pr</b>
------------	-------------------------	------------------

### POST SLEEVES SOLD SEPARATELY

<b>00444000</b>	<i>Outdoor Ground Sleeve, Square Cover</i>	<b>\$326</b>
<b>00885800</b>	<i>Indoor Elite Floor Sleeve, Chrome Cover</i>	<b>\$372</b>
<b>00885900</b>	<i>Indoor Elite Floor Sleeve, Brass Cover</i>	<b>\$341</b>
<b>00872100</b>	<i>Indoor Essentials Floor Sleeve, Chrome Cover</i>	<b>\$250</b>
<b>00872200</b>	<i>Indoor Essentials Floor Sleeve, Brass Cover</i>	<b>\$250</b>

## SOLD SEPARATELY

<b>2235</b>	<i>Tennis Net 42' x 39"</i>	<b>\$415</b>
<b>00885500</b>	<i>Singles Stick Net Support</i>	<b>\$188</b>
<b>02238000</b>	<i>Center Tie Down Strap</i>	<b>\$50</b>
<b>02239000</b>	<i>Outdoor Center Strap Anchor</i>	<b>\$47</b>
<b>02238100</b>	<i>Indoor Center Strap Anchor</i>	<b>\$87</b>
<b>02991340</b>	<i>Indoor Tennis Net 34' x 39"</i>	<b>\$579</b>
<b>010970XX</b>	<i>Indoor Tennis Pads</i>	<b>\$533</b>



## TENNIS BENCH

See page 24



**GILL**  
ATHLETICS



# CHAMPIONSHIP ATMOSPHERE DESERVES CHAMPIONSHIP EQUIPMENT.

*The best athletes. The biggest meets. Shared and relived by champions everywhere. Prepare your event how it deserves to be experienced and remembered – by using athletic equipment trusted at the highest levels of competition.*



Since 1918, Gill Athletics® has empowered coaches with innovative equipment, helping coaches develop athletes and elevate sports across the globe.



[GILLATHLETICS.com](http://GILLATHLETICS.com)

**GILL**  
ATHLETICS

**FEATURING**

**PORTER®**

**OWN  
— THE —  
COURT**

*For over 150 years, Porter Athletic equipment has been trusted for smooth installation and set-up, outstanding service and support, and unsurpassed quality and durability.*



**HEAVY-DUTY SYSTEM**

 **UNCONDITIONAL** LIFETIME WARRANTY

Heavy-duty support structure provides tremendous strength and is designed to withstand the most rugged playing conditions. Backstop provides a 5' extension into the playing court for maximum safety. Available as a single post or a back-to-back system when a multiple court layout is desired. Unconditional Lifetime Warranty is provided on the most rugged outdoor goal available. Great system for regulation outdoor competitions.

Official size 72" x 42" perforated backboard is 11 gauge steel with a massive rear support framework. Backboard is screened with official perimeter and target area markings. Backboard, goal and pole have an extremely durable powder coated finish.

195580	Standard System	\$5270
195582	Back-to-Back System	\$8480
95758	Pole Pad	\$581
00324672	Backboard Pad	\$271



**ULTIMATE OUTDOOR SYSTEM**

 **10** YEAR LIMITED WARRANTY

Turn any outdoor court into an official arena! Includes 6' vertical pole, 72" x 42" Center-Strut glass backboard, 240180 Torq-Flex Competition, and anti-whip net.

*Pole pad and backboard pad not included, but recommended for player safety.*

16675CXX \$3800



**Ultimate Outdoor Powder Coat Colors**  
See color chart on page 51 to replace the XX in the item numbers.

# BASKETBALL

## BIG SHOT®

### BIG SHOT® PRO SYSTEM

Features a rugged 6" upright post anchored into the ground utilizing an anchor bolt system. The 72" x 42" clear-view backboard features ½" glass and comes standard with edge padding. Official white perimeter and target area markings are silk screened on the backside to prevent wear. The extension arms offer 4' of clearance for player safety and allow the backboard to be set at any playing height from 5.5' to 10'. System is assembled using premium stainless steel hardware. Includes the Powr-Flex Competition goal, a moveable rim that protects players and equipment during slam-dunks with a concealed shock absorber.

*INCLUDED: 72" x 42" Glass Backboard, Goal, Nylon Net, Post & Backboard Pads, & Mounting Hardware.*

9572	Pro Package	\$2600
95758	Replacement 6" Pole Pad	\$581



### BIG SHOT® ELITE SYSTEM

Features a 5" upright post anchored into the ground utilizing an anchor bolt system. The 60" x 36" glass backboard includes official white perimeter and target area markings silk screened on the backside to prevent wear. The system features 2.5' extension arms and can be set at any playing height from 7.5' to 10'. System is assembled using zinc plated hardware. Includes the flex goal, a moveable rim that protects players and equipment during slam-dunks with a concealed shock absorber.

*INCLUDED: 60" x 36" Glass Backboard, Goal, Nylon Net, Post & Backboard Pads, & Mounting Hardware.*

9571	Elite Package	\$1800
95705	Replacement Backboard Pad	\$315
95708	Replacement 5" Pole Pad	\$509



### BIG SHOT® COMPETITION SYSTEM

Features a 4" upright post anchored into the ground utilizing an anchor bolt system. The 48" x 32" glass backboard includes official white perimeter and target area markings are silk screened on the backside to prevent wear. The system features 2.5' extension arms and can be set at any playing height from 7.5' to 10'. System is assembled using zinc plated hardware. Includes the Powr-Flex Competition goal, a moveable rim that protects players and equipment during slam-dunks with a concealed shock absorber.

*INCLUDED: 48" x 32" Glass Backboard, Goal, Nylon Net, Post & Backboard Pads, & Mounting Hardware.*







9570	Competition Package	\$1200
------	---------------------	--------



# GOOSENECK SYSTEMS







 **10** YEAR LIMITED WARRANTY

USE THE MATRIX TO CHOOSE YOUR EXTENSION DISTANCE, POLE DIAMETER, BACKBOARD, AND GOAL

<b>4' Extension</b> <b>4½" Diameter Pole</b>		00235000 Super Goal 	00202H00 Double Rim 	00251H00 Heavy-Duty 	236H00 Powr-Flex Competition 
267 Fan Fiberglass		\$1,150 17412	\$1,180 17413	\$1,260 17414	\$1,385 17415
234A Fan Aluminum		\$1,340 17432	\$1,360 17433	\$1,425 17434	\$1,425 17435



Discover Our  
Most Popular  
Combinations











<b>5' Extension</b> <b>4½" Diameter Pole</b>					
267 Fan Fiberglass		\$1,505 17512	\$1,535 17513	\$1,630 17514	\$1,735 17515
234A Fan Aluminum		\$1,545 17532	\$1,585 17533	\$1,675 17534	\$1,790 17535
216 72" x 42" Fiberglass		\$1,805 17582	\$1,835 17583	\$1,920 17584	\$2,045 17585

### Super Duty System

Provides the utmost in safety and strength during even the toughest play. California and Florida specifications require extended pole length for a 2' deeper footing.

00251H00  
Heavy-Duty

236H00  
Powr-Flex  
Competition

<b>6' Extension</b> <b>5<sup>9</sup>/<sub>16</sub>" Diameter Pole</b>							
267 Fan Fiberglass		\$2,805 17612	\$2,880 17613	\$2,930 17614	\$3,065 17615	---	
234A Fan Aluminum		\$2,860 17632	\$2,880 17633	\$2,970 17634	\$3,090 17635	\$4,080 176FLSD340	\$4,115 176FLSD350
207 72" x 42" Steel		\$3,205 17652	\$3,225 17653	\$3,325 17654	\$3,445 17655	\$4,770 176FLSD540	\$4,820 176FLSD550
205A 72" x 42" Glass		\$3,110 17662	\$3,125 17663	\$3,220 17664	\$3,335 17665	\$4,250 176FLSD640	\$4,295 176FLSD650
216 72" x 42" Fiberglass		\$3,130 17682	\$3,170 17683	\$3,260 17684	\$3,365 17685	---	---







# VERTICAL POST SYSTEMS

 **10** YEAR LIMITED WARRANTY

## Super Duty System

Provides the utmost in safety and strength during even the toughest play. California and Florida specifications require extended pole length for a 2' deeper footing.

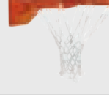
USE THE MATRIX TO CHOOSE YOUR EXTENSION DISTANCE, POLE DIAMETER, BACKBOARD, AND GOAL











4' Extension 4½" Diameter Pole		00235000 Super Goal 	00202H00 Double Rim 	00251H00 Heavy-Duty 	236H00 Powr-Flex Competition 	00251H00 Heavy-Duty 	236H00 Power-Flex Competition 
267 Fan Fiberglass		\$2,255 16412	\$2,355 16413	\$2,445 16414	\$2,505 16415	---	---
234A Fan Aluminum		\$2,595 16432	\$2,685 16433	\$2,770 16434	\$2,845 16435	\$3,290 164FLSD340	\$3,600 164FLSD350
216 72" x 42" Fiberglass		\$2,710 16482	\$2,685 16483	\$2,770 16484	\$2,845 16485	---	---

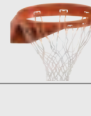
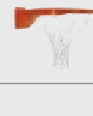

Also Available in Back-To-Back Configurations.  
Call For Pricing & Details.

## Super Duty System

Provides the utmost in safety and strength during even the toughest play. California and Florida specifications require extended pole length for a 2' deeper footing.

6' Extension 5⅞" Diameter Pole							
267 Fan Fiberglass		\$2,320 16612	\$2,390 16613	\$2,455 16614	\$2,610 16615	---	---
234A Fan Aluminum		\$2,700 16632	\$2,770 16633	\$2,845 16634	\$2,900 16635	---	---
207 72" x 42" Steel		\$3,610 16652	\$3,625 16653	\$3,680 16654	\$3,625 16655	\$4,795 166FLSD540	\$4,850 166FLSD550
205A 72" x 42" Glass		\$2,835 16662	\$2,880 16663	\$2,955 16664	\$3,005 16665	\$4,405 166FLSD640	\$4,465 166FLSD650
216 72" x 42" Fiberglass		\$2,740 16682	\$2,805 16683	\$2,875 16684	\$2,925 16685	---	---

# VOLLEYBALL

## POWR-SAND™ OUTDOOR STANDARD

 **10** YEAR LIMITED WARRANTY

Powr-Sand, Porter's aluminum telescoping standard, was created for top level competition with thoughtful features that allow users to have equipment remain outdoors year round or remove when not in use. A pin stop telescoping standard with powdered coated handle is easily adjustable across all competitive volleyball heights. Pair the Powr-Sand standards with our high visibility Powr-Sand outdoor volleyball net, protective padding, boundary marker antennas, court marking kit and optional sand judge's stand for all the equipment needed for training and competition.

- Constructed Of High Strength, Lightweight Aluminum
- Two Reinforcing Ribs Are Centered Throughout The Entire Length Of The Post For Added System Strength
- Sealed Lower Upright Prevents Water/Sand Build-Up
- Features Heavy Duty Winch With Cover
- Pin-Lock Net Height Adjustment
- Functional Multi-Use System Provides Height Adjustment Settings For Men's, Women's And Junior USAV Competitions



**STANDARD PACKAGE - 3 1/2"**      30911XX      \$4460

Package Includes:

- 3091 Powr-Sand Standards (pr)
- 8390XX Official Upright Protective Pads (pr)
- 2256 Outdoor Competition Net
- 2297 Powr-Select Net Antennas (pr)
- NETCHAIN Fair Height Net Chain

**INTERNATIONAL PACKAGE - 3 1/2"**      30910XX      \$5910

Package Includes:

- 3091 Powr-Sand Standards (pr)
- 8390XX Official Upright Protective Pads (pr)
- 2256 Outdoor Competition Net
- 2297 Powr-Select Net Antennas (pr)
- NETCHAIN Fair Height Net Chain
- 3070 Powr-Sand Judge's Stand
- 6693XX Powr-Sand Judge's Stand Padding
- 451 Sand Rake

### Vinyl



Use the two-digit number of your color selection to replace XX in the item number.

## POWR-SAND STANDARDS & PADS

3091	Powr-Sand Standards	\$3085/pr
3060XX	Powr-Sand Pads	\$948/pr

## GROUND SLEEVES

3080	Sand Ground Sleeves	\$639/ea
------	---------------------	----------

## JUDGE'S STAND & STAND PADS

3070	Judge's Stand	\$863
6693XX	Judge's Stand Padding	\$538

GRAPHIC PADS      Call for Details

## PROFESSIONAL OUTDOOR COURT LINE KIT

Durable 2" nylon volleyball line system for quickly and efficiently marking outdoor volleyball courts. Adjustable to USAV regulation or short court. Includes ground stakes and plastic reel. Available in blue or black.



TA380	Blue	\$136
-------	------	-------



**GILL**  
ATHLETICS

**FEATURING**

**porter**<sup>®</sup>

#### ULTIMATE OUTDOOR VOLLEYBALL STANDARDS

Height adjustable posts are constructed of high-tensile strength, lightweight aluminum for durability and easy set-up. Uprights are 4" square with a built-in channel running the length of the post which allows the collar to easily slide up and down the post, providing infinite height settings. Finished in a weather resistant clear anodized finish. Net not included.

591 \$1735/pr

#### SOLD SEPARATELY

2256 27'10" x 3'3" Net \$269/ea

00444000 Ground Sleeve for Dirt \$326/ea

5930XX Protective Pads \$608/pr

Sand Unit:

592 Sand Conversion Kit \$283/pr

00444040 Ground Sleeve for Sand \$268/ea

**OWN**  
— THE —  
**COURT**

*For over 150 years, Porter Athletic equipment has been trusted for smooth installation and set-up, outstanding service and support, and unsurpassed quality and durability.*

**FEATURING**

**porter**<sup>®</sup>



601 Mercury Drive  
Champaign, IL 61822  
USA



**QUALITY INNOVATION COMMITMENT**

**QUALITY  
INNOVATION  
COMMITMENT**

**GILLATHLETICS.COM 800.637.3090 TRACK&FIELD FOOTBALL SOCCER BASEBALL TENNIS BASKETBALL VOLLEYBALL**