

VOLLEYBALL VOLLEY 2026

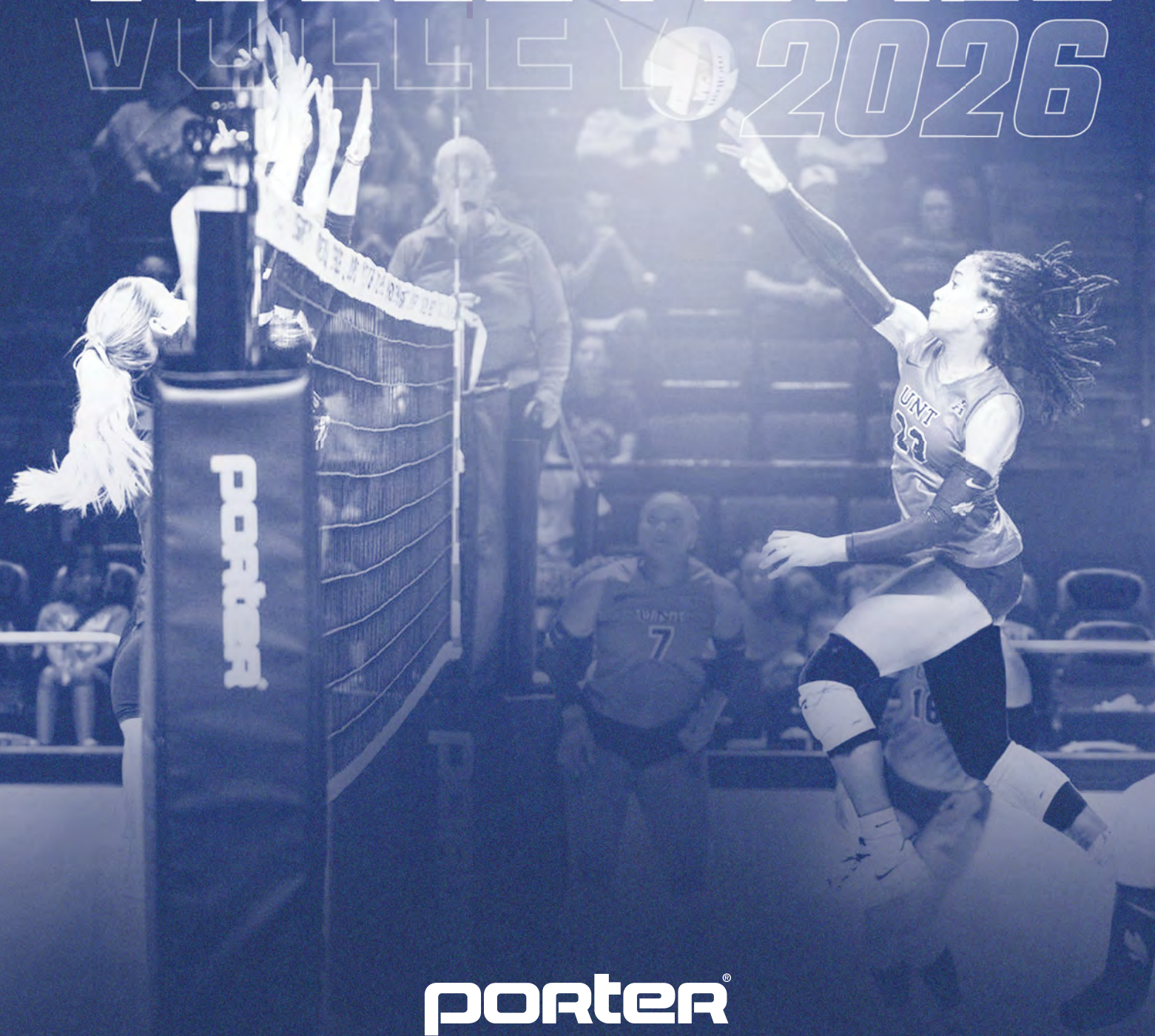

porter[®]

PORTERATHLETIC.COM



porter®

IT'S
YOUR
COURT,
OWN IT.

STANDARDS | PADS | JUDGE'S STANDS | NETS

For over 150 years, coaches have chosen Porter Athletic equipment for unsurpassed quality, service, and industry-leading features. Our equipment is designed with the safety and performance of athletes at the forefront. We care about your success, and work relentlessly to maintain your trust and confidence.

2026 VOLLEYBALL

EQUIPMENT COLLECTION

At Porter Athletic, our mission is to continually improve our processes, products, expertise, and service to create superior opportunities for athletic success.

PORTER[®]

WHAT'S INSIDE



04 *POWR-Carbon™ II*

06 *POWR-Hybrid™*

08 *POWR-Line™*

10 *POWR-Steel™*

12 *POWR-Rib™ II*

14 *POWR-Sand™*

16 *POWR-Court™ Pro*

18 *Upright Padding*

19 *Custom Graphics*

20 *Judge's Stand*

22 *Nets & Accessories*

24 *Sleeves, Plates & Anchors*

26 *Sport Standards*

28 *Recreational Standards*

30 *Training*



Prices effective from January 1, 2026 through December 31, 2026. Prices may be subject to change.

HARNESS THE POWER



RIB™ II



STEEL



LINE

3.5 3	3	3.5 3
Aluminum	Steel	Aluminum
38 lbs	50 lbs	45 lbs
10 Year	LIFETIME	10 Year
NFHS	✓	✓
	✓	✓
✓		
Pressure Lock Collar	Tethered Steel Pin	Pressure Lock Collar

POWR SERIES

ALL POWR SERIES STANDARDS ARE:



CUSTOM GRAPHICS
ON UPRIGHT PADS



10 YEAR
LIMITED WARRANTY



HYBRID™

CARBON™ II

CHOOSE YOUR BEST FIT

3	3
Carbon + Aluminum	Carbon
26 lbs	19 lbs
10 Year	LIFETIME
✓	✓
✓	✓
Pin Stop	Pin Stop

Sleeve Diameter Compatibility
Material
Weight (ea)
Warranty
Meets FIVB/NCAA/NFHS Specifications
Telescoping
Multi-Sport
Height Adjustment Type

POWR-CARBON™ II

meets requirements for
FIBA, NCAA, & NFHS



Competition Package

20931XX 3" Diameter \$6,730

PACKAGE INCLUDES:

2093 Powr-Carbon II Standards (pr), 8390XX Official Upright Protective Pads (pr), 2295 Competition Net, 2297 Powr-Select Net Antenna (pr), **NETCHAIN** Fair Height Net Chain



CUSTOMIZE IT!
SEE PAGE 19

Vinyl Colors: (xx)

01 LIGHT BLUE	02 ROYAL BLUE	03 RED	04 WHITE	05 ORANGE	06 YELLOW GOLD	08 TAN
09 GRAY	10 MAROON	11 PURPLE	12 BLACK	13 NAVY BLUE	14 KELLY GREEN	15 DARK GREEN

Competition Package PLUS

20930XX 3" Diameter \$7,520

PACKAGE INCLUDES:

2093 Powr-Carbon II Standards (pr), 8390XX Official Upright Protective Pads (pr), 2295 Competition Net, 2297 Powr-Select Net Antenna (pr), **NETCHAIN** Fair Height Net Chain, 669100 Free Standing Judge's Stand, 6693XX Judge's Stand Padding



End Standards

2093 3" Diameter \$5,760 (pr)
20939XX 3" Diameter with Official Pads \$6,795 (pr)

ONLY
19lbs!



**POWR
CARBON
II**

Powr-Carbon II, Porter's premier competition level standard, provides exceptional strength and is extremely lightweight. Its unique design is crafted from incredibly strong carbon fiber material making it our lightest system.

- **DESIGNED FOR TOP LEVEL COMPETITION**
- **100% CARBON FIBER STANDARDS**
- **TELESCOPING STANDARD WITH PRE-DRILLED HOLES AND PIN STOP**
- **POWR-SELECT WINCH**
- **3" DIAMETER POSTS**
- **19LB PER STANDARD**
- **MEETS FIVB, NCAA, NFHS SPECIFICATIONS**
- **LIFETIME LIMITED WARRANTY**
- **MADE IN THE USA**
- **NET AND FLOOR SLEEVES SOLD SEPARATELY**



LIFETIME LIMITED WARRANTY

POWR-HYBRID™

meets requirements for
FIBA, NCAA, & NFHS

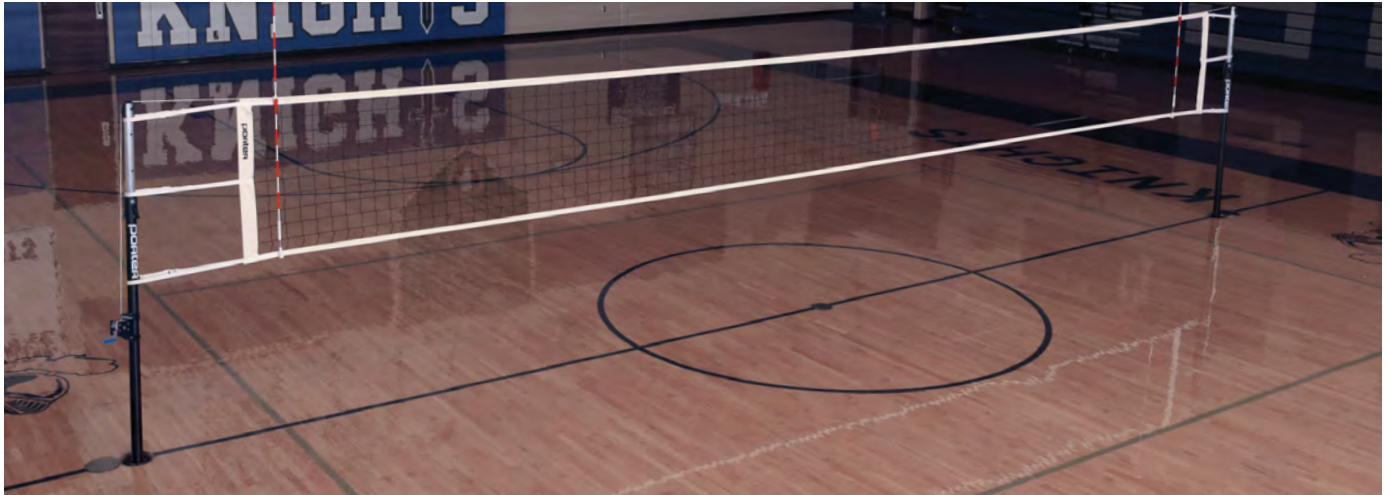

Competition Package

10931XX 3" Diameter \$5,830

PACKAGE INCLUDES:

1093 Powr-Hybrid Standards (pr), 8390XX Official Upright Protective Pads (pr), 2295 Competition Net, 2297 Powr-Select Net Antenna (pr), **NETCHAIN** Fair Height Net Chain



CUSTOMIZE IT!
SEE PAGE 19

Vinyl Colors: (xx)

01 LIGHT BLUE	02 ROYAL BLUE	03 RED	04 WHITE	05 ORANGE	06 YELLOW GOLD	08 TAN
09 GRAY	10 MAROON	11 PURPLE	12 BLACK	13 NAVY BLUE	14 KELLY GREEN	15 DARK GREEN

Competition Package PLUS

10930XX 3" Diameter \$6,510

PACKAGE INCLUDES:

1093 Powr-Hybrid Standards (pr), 8390XX Official Upright Protective Pads (pr), 2295 Competition Net, 2297 Powr-Select Net Antenna (pr), **NETCHAIN** Fair Height Net Chain, 669100 Free Standing Judge's Stand, 6693XX Judge's Stand Padding



End Standards

1093 3" Diameter \$4,985 (pr)
10939XX 3" Diameter with Official Pads \$5,880 (pr)

ADJUSTABLE FOOT

Fine tune to correct sleeve height and ensure easy assembly every time*

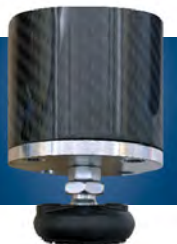

*Available on Carbon II and Hybrid Standards



**POWR
HYBRID**

Powr-Hybrid™ is Porter's next-generation competition standard, synthesizing rigid strength with lightweight functionality. It's revolutionary design uses our incredibly strong carbon fiber material combined with an aluminum inner standard, making it our second lightest system.

- **DESIGNED FOR TOP LEVEL COMPETITION**
- **CARBON FIBER STANDARDS WITH ALUMINUM INNER UPRIGHT**
- **TELESCOPING STANDARD WITH PRE-DRILLED HOLES AND PIN STOP**
- **POWR-SELECT WINCH**
- **3" DIAMETER POSTS**
- **26LB PER STANDARD**
- **MEETS FIVB, NCAA, NFHS SPECIFICATIONS**
- **10 YEAR LIMITED WARRANTY**
- **MADE IN THE USA**
- **NET AND FLOOR SLEEVES SOLD SEPARATELY**

 **10** YEAR LIMITED WARRANTY

POWR-LINE™

meets requirements for
FIBA, NCAA, & NFHS



Considering a Powr-Line Package? Check out our Powr-Court System on page 16.

Competition Package

- 19831XX** 3" Diameter \$5,635
- 19811XX** 3½" Diameter \$5,635

PACKAGE INCLUDES:

1993 or 1991 Powr-Line Standards (pr), 8390XX Official Upright Protective Pads (pr), 2295 Competition Net, 2297 Powr-Select Net Antenna (pr), **NETCHAIN** Fair Height Net Chain



CUSTOMIZE IT!
SEE PAGE 19

Vinyl Colors: (xx)

01 LIGHT BLUE	02 ROYAL BLUE	03 RED	04 WHITE	05 ORANGE	06 YELLOW GOLD	08 TAN
09 GRAY	10 MAROON	11 PURPLE	12 BLACK	13 NAVY BLUE	14 KELLY GREEN	15 DARK GREEN

Competition Package PLUS

- 19830XX** 3" Diameter \$6,935
- 19810XX** 3½" Diameter \$6,935

PACKAGE INCLUDES:

1993 or 1991 Powr-Line Standards (pr), 8390XX Official Upright Protective Pads (pr), 2295 Competition Net, 2297 Powr-Select Net Antenna (pr), **NETCHAIN** Fair Height Net Chain, 669100 Free Standing Judge's Stand, 6693XX Judge's Stand Padding



End Standards

- 1993** 3" Diameter \$4,175 (pr)
- 19939XX** 3" with Official Pads \$4,780 (pr)
- 1991** 3½" Diameter \$4,175 (pr)
- 19919XX** 3½" with Official Pads \$4,780 (pr)

Telescoping Center Standards

- 1994** 3" Diameter \$3,075 (ea)
- 19949XX** 3" with Official Pad \$3,660 (ea)
- 1992** 3½" Diameter \$3,075 (ea)
- 19929XX** 3½" with Official Pad \$3,660 (ea)



**POWR
LINE**

Porter's Powr-Line™ standards are engineered and manufactured to meet the exacting demands of championship play with maximum safety. This telescoping system is constructed of high strength, lightweight aluminum.

- DESIGNED FOR ALL LEVELS
- ALUMINUM STANDARDS
- TELESCOPING STANDARD WITH T HANDLE PRESSURE LOCK
- POWR-SELECT WINCH
- 3" AND 3-1/2" DIAMETER POSTS
- 45LB PER STANDARD
- MEETS FIVB, NCAA, NFHS SPECIFICATIONS
- 10 YEAR LIMITED WARRANTY
- MADE IN THE USA
- NET AND FLOOR SLEEVES SOLD SEPARATELY
- TELESCOPING CENTER STANDARD AVAILABLE FOR MULTI-COURT SETUP

 **10** YEAR LIMITED WARRANTY

POWR-STEEL™

meets requirements for
FIBA, NCAA, & NFHS



Competition Package

17911XX 3" Diameter \$4,795

PACKAGE INCLUDES:

1791 Powr-Steel Standards (pr), 8390XX Official Upright Protective Pads (pr), 2295 Competition Net, 2297 Powr-Select Net Antenna (pr), NETCHAIN Fair Height Net Chain



CUSTOMIZE IT!
SEE PAGE 19

Vinyl Colors: (xx)

01 LIGHT BLUE	02 ROYAL BLUE	03 RED	04 WHITE	05 ORANGE	06 YELLOW GOLD	08 TAN
09 GRAY	10 MAROON	11 PURPLE	12 BLACK	13 NAVY BLUE	14 KELLY GREEN	15 DARK GREEN

Competition Package PLUS

17910XX 3" Diameter \$6,100

PACKAGE INCLUDES:

1791 Powr-Steel Standards (pr), 8390XX Official Upright Protective Pads (pr), 2295 Competition Net, 2297 Powr-Select Net Antenna (pr), NETCHAIN Fair Height Net Chain, 669100 Free Standing Judge's Stand, 6693XX Judge's Stand Padding



End Standards

1791 3" Diameter \$3,295 (pr)
17919XX 3" with Official Pads \$4,435 (pr)

Telescoping Center Standards

1792 3" Diameter \$1,915 (ea)
17929XX 3" with Official Pad \$2,535 (ea)



**POWR
STEEL**

Porter's Powr-Steel™ standards are a combination of endless function, style, and stability. This system's infrastructure is built to last with an extremely durable frame and steel uprights that provide ultimate stability and firm net tensioning.

- **DESIGNED FOR COLLEGE LEVEL PLAY**
- **STEEL STANDARDS POWDER COATED IN CORROSION RESISTANT NAVY BLUE**
- **TELESCOPING STANDARD WITH PRE-DRILLED HOLES AND PIN STOP**
- **POWR-SELECT WINCH**
- **3" DIAMETER POSTS**
- **50LB PER STANDARD**
- **MEETS FIVB, NCAA, NFHS SPECIFICATIONS**
- **LIFETIME LIMITED WARRANTY**
- **MADE IN THE USA**
- **NET AND FLOOR SLEEVES SOLD SEPARATELY**
- **TELESCOPING CENTER STANDARD AVAILABLE FOR MULTI-COURT SETUP**



LIFETIME LIMITED WARRANTY

POWR-RIB™ II

meets requirements for
NFHS



Competition Package

- 19631XX 3" Diameter \$4,585
- 19611XX 3 1/2" Diameter \$4,440

PACKAGE INCLUDES:

1973 or 1971 Powr-Rib II Standards (pr), 8390XX Official Upright Protective Pads (pr), 2295 Competition Net, 00546000 Boundary Marker with Antennas (pr), **NETCHAIN** Fair Height Net Chain



CUSTOMIZE IT!
SEE PAGE 19

Vinyl Colors: (xx)

01 LIGHT BLUE	02 ROYAL BLUE	03 RED	04 WHITE	05 ORANGE	06 YELLOW GOLD	08 TAN
09 GRAY	10 MAROON	11 PURPLE	12 BLACK	13 NAVY BLUE	14 KELLY GREEN	15 DARK GREEN

Competition Package PLUS

- 19630XX 3" Diameter \$5,775
- 19610XX 3 1/2" Diameter \$5,745

PACKAGE INCLUDES:

1973 or 1991 Powr-Rib II Standards (pr), 8390XX Official Upright Protective Pads (pr), 2295 Competition Net, 2297 Powr-Select Net Antenna (pr), **NETCHAIN** Fair Height Net Chain, 669100 Free Standing Judge's Stand, 6693XX Judge's Stand Padding



End Standards

- 1973 3" Diameter \$3,070 (pr)
- 19739XX 3" with Official Pads \$4,010 (pr)
- 1971 3 1/2" Diameter \$2,920 (pr)
- 19719XX 3 1/2" with Official Pads \$3,845 (pr)

Split Collar Center Standards

- 1974 3" Diameter \$2,060 (ea)
- 19749XX 3" with Official Pad \$2,685 (ea)
- 1972 3 1/2" Diameter \$1,730 (ea)
- 19729XX 3 1/2" with Official Pad \$2,335 (ea)

**POWR
RIB II**

The Powr-Rib II standard is constructed of high strength, lightweight aluminum. Two reinforcing ribs are centered throughout the entire length of the post for added system strength. A built in channel runs the length of the post allowing multipurpose functionality for volleyball, badminton, and tennis play.

- **RECOMMENDED FOR JUNIOR HIGH, HIGH SCHOOL, AND INTRAMURAL SPORTS. MULTI-SPORT PLAY**
- **SINGLE PIECE ALUMINUM STANDARDS WITH DUAL REINFORCING RIBS**
- **SLIDING COLLAR WITH T HANDLE PRESSURE LOCK**
- **POWR-SELECT WINCH**
- **3" AND 3-1/2" DIAMETER POSTS**
- **38LB PER STANDARD**
- **MEETS NFHS SPECIFICATIONS**
- **10 YEAR LIMITED WARRANTY**
- **MADE IN THE USA**
- **NET AND FLOOR SLEEVES SOLD SEPARATELY**
- **SPLIT COLLAR CENTER STANDARD AVAILABLE FOR MULTI-COURT, MULTI-SPORT SETUP**

 **10** YEAR LIMITED WARRANTY

POWR-SAND™

meets requirements for
FIBA, NCAA, & NFHS



Competition Package

30911XX 3½" Diameter **\$4,520**

PACKAGE INCLUDES:

3091 Powr-Sand Standards (pr), 8390XX Official Upright Protective Pads (pr), 2256 Outdoor Competition Net, 2297 Powr-Select Net Antenna (pr), **NETCHAIN** Fair Height Net Chain



CUSTOMIZE IT!
SEE PAGE 19

Vinyl Colors: (xx)

01 LIGHT BLUE	02 ROYAL BLUE	03 RED	04 WHITE	05 ORANGE	06 YELLOW GOLD	08 TAN
09 GRAY	10 MAROON	11 PURPLE	12 BLACK	13 NAVY BLUE	14 KELLY GREEN	15 DARK GREEN

Competition Package PLUS

30910XX 3½" Diameter **\$5,905**

PACKAGE INCLUDES:

3091 Powr-Sand Standards (pr), 3060XX Powr-Sand Pads (pr), 2256 Outdoor Competition Net, 2297 Powr-Select Net Antenna (pr), **NETCHAIN** Fair Height Net Chain, 3070 Powr-Sand Judge's Stand, 6693XX Powr-Sand Judge's Stand Padding, 451 Sand Rake



Powr-Sand Standards & Pads

3091 Powr-Sand Standards **\$3,210 (pr)**
3060XX Powr-Sand Pads **\$986 (pr)**

Judge's Stand & Stand Pads

3070 Judge's Stand **\$898**
6693XX Judge's Stand Padding **\$560**

Ground Sleeves

3080 Sand Ground Sleeves **\$735 (ea)**



Professional Outdoor Court Line Kit

Durable 2" nylon volleyball line system for quickly and efficiently marking outdoor volleyball courts. Adjustable to USAV regulation or short court. Includes ground stakes and plastic reel.

TA380 **\$136**



**POWR
SAND**

Powr-Sand™, Porter's aluminum telescoping standard, was created for top level competition with thoughtful features that allow users to have equipment remain outdoors year round or remove when not in use. A pin stop telescoping standard with powdered coated handle is easily adjustable across all competitive volleyball heights. Pair the Powr-Sand standards with our high visibility Powr-Sand outdoor volleyball net, protective padding, boundary marker antennas, court marking kit and optional sand judge's stand for all the equipment needed for training and competition.

- **LIGHTWEIGHT ALUMINUM CONSTRUCTION**
- **REINFORCING RIBS FOR ADDED STRENGTH**
- **SEALED LOWER UPRIGHT**
- **HEAVY DUTY OUTDOOR WINCH**
- **PIN-LOCK NET HEIGHT ADJUSTMENT**

 **10** YEAR LIMITED WARRANTY

POWR-COURT™



CUSTOM GRAPHICS AVAILABLE

meets requirements for FIBA, NCAA, & NFHS

A completely portable system utilizing Powr-Line uprights that is designed for competition and recreational play. The 750lb ballast base and no-creep foot pad keep the base in position during use. The system's crank lifts the base and allows it to maneuver. Upgrade your system by adding an optional fitted judge's stand and customized upright padding.

- 1935XX Standard System \$14,890 (pr)
- 1935XXSP System With Custom Graphics \$15,240 (pr)

SOLD SEPARATELY See Page 24 For Details

- 00999000 Judge's Stand \$1,215
- 9931XX Judge's Stand Padding \$693

Vinyl Colors: (xx)

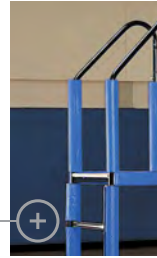

*Optional Judge's Stand Shown



*Custom Graphics Shown

Powr Court / Powr Court Pro Systems Include



Portable Powr-Court Pro Bases with Integrated Judge's Stand and Padding

OR



Portable Powr-Court Bases with Integrated Padding
Optional Judges Stand Shown



Competition Net

(2) Powr-Select Net Antenna

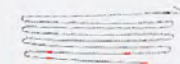

Fair Height Net Chain



Powr-Select Winch

POWR-COURT™ PRO



CUSTOM GRAPHICS AVAILABLE

meets requirements for:
FIVB NCAA NFHS

- 1945CXX Standard System \$22,165 (pr)
- 1945CXXSP System With Custom Graphics \$22,865 (pr)

Vinyl Colors: (xx)

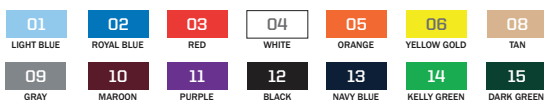

*Custom Graphics Shown





**Custom Graphics Shown*

POWR COURT PRO

Introducing Powr-Court Pro™, a truly portable volleyball system. Powr-Court Pro quickly and easily transforms almost any location into a volleyball court. The steel telescoping standards have infinite height adjustment settings and are welded to ballasted bases. With a ballast of 500lb per base this system is secure, does not require floor anchors, and will not “creep.” One base unit is equipped with a built-in judge’s stand including anti-fatigue mat. The second base unit houses the universal winch. Bases are padded with thick shock absorbing foam and covered in a heavy 19oz vinyl. Each base includes 4 non-marking caster wheels.

The system comes complete with 2 padded bases, a competition net, net antennas, and net height chain. Customize with your choice of color for the vinyl pads and base frame. Custom graphics available on base pads for additional cost. The Powr-Court weldments are backed by a lifetime limited warranty; 1 year warranty on all other parts.

- ENTIRE SYSTEM COMPLIES WITH USAV, NCAA, AND NFHS REQUIREMENTS
- STANDARDS MARKED WITH FOUR NET HEIGHTS: 10's, 12's, WOMEN'S, AND MEN'S

 **10** YEAR LIMITED WARRANTY



CUSTOMIZE IT!
SEE PAGE 19

UPRIGHT PADDING



CUSTOM GRAPHICS
AVAILABLE



CUSTOMIZE IT!



Official Upright Pads

Neatly covers upright, winch and net tensioning hardware while providing maximum visibility for both spectators and judges. Tailored pads are miter cut and hinged to fold around uprights and tensioning reels providing a slim profile. Durable polyester reinforced 20oz vinyl with 1½" thick polyethylene filler. Hook and loop fastening system. Pads are 6' in height above the floor to meet or exceed USAV, NFHS and NCAA requirements for player safety and protection.

- 8390XX End Pads \$871 (pr)
- 8391XX Center Pad \$619 (ea)

When Ordering: Use the two-digit vinyl color number to replace XX in the item number.

IT'S YOUR COURT

01 LIGHT BLUE

02 ROYAL BLUE

03 RED

04 WHITE

05 ORANGE

06 YELLOW

08 TAN

09 GRAY

10 MAROON

11 PURPLE

12 BLACK

13 NAVY BLUE

14 KELLY GREEN

15 DARK GREEN

CUSTOM GRAPHICS

Give your court a true home team advantage with custom printed graphic upright pads! Simply provide your logo vector artwork and our design team works with you to create a stunning display.



LOOK FOR THIS ICON

Custom Graphics Add SP to end of item # Call For Pricing



Volleyball Net Sleeve

Show your team spirit with this fully customizable volleyball top tape net sleeve. Hook and loop closure attaches to any manufacturers' net quickly without affecting net playability. Constructed of heavy 20oz vinyl-coated polyester fabric material. 100 P.S.I. tear strength.

NETSLVE0032 \$534

JUDGE'S STANDS



Free Standing Judge's Stand

Free standing, portable judge's stand with 48" tall platform to elevate a referee's head above the top of the net for competition volleyball requirements. Platform and ladder fold compactly against front upright for ease of transport and storage. Front upright and ladder support fitted with non marking, rubber floor pads. Equipped with two wheels for easy transportation. Frame is durable black powder-coat finish with gray padded platform.

669100	Free Standing Judge's Stand	\$812
6693XX	Free Standing Stand Pads	\$560

Vinyl Colors: (xx)

01 LIGHT BLUE	02 ROYAL BLUE	03 RED	04 WHITE	05 ORANGE
06 YELLOW GOLD	08 TAN	09 GRAY	10 MAROON	11 PURPLE
12 BLACK	13 NAVY BLUE	14 KELLY GREEN	15 DARK GREEN	



Fitted Judge's Stand

Designed specifically for use with Porter's competition volleyball systems. Wide stance, vertical ladder type support frame provides excellent stability for all levels of competition. Nominal two foot square platform with formed side rails provides a secure platform with an excellent viewing position. Non-marking rubber feet and 3" diameter wheels allow for easy tipping and rolling to and from storage areas. Powder-coated finish provides the utmost in durability. This stand is designed for maximum spectator visibility when used with optional protective padding kit to meet all requirements for competition.

00889100	Fits Powr-Rib II, Powr-Trak, and Economy	\$1,275
00999000	Fits Powr-Line	\$1,215
779100	Fits Powr-Steel and Powr-Carbon II	\$1,395

9931XX	Fitted Stand Pads	\$693
7731XX	Fitted Stand Pads; Powr-Steel, Powr-Carbon II	\$657

Vinyl Colors: (xx)

01 LIGHT BLUE	02 ROYAL BLUE	03 RED	04 WHITE	05 ORANGE
06 YELLOW GOLD	08 TAN	09 GRAY	10 MAROON	11 PURPLE
12 BLACK	13 NAVY BLUE	14 KELLY GREEN	15 DARK GREEN	



COACH'S STAND



Volleyball Coach's Stand

Elevate above the net for practice and training. The all steel design provides stability with a 400 lb. capacity. Easy-to-use foot levers lock in place while providing quick stop-and-go mobility during practices. Side panels allow for full customization.

8571SP	24"x 36" x18"	\$1,470
8570SP	44"x 36" x 24"	\$1,705



Foot lever in UNLOCKED position



Foot lever in LOCKED position

NETS & ACCESSORIES

“Porter side straps are great at providing extra tension throughout the net. This allows for more balls to be played out of the net versus other competitor’s nets that are too loose.”

- Brenda Williams, Former Head Coach at ONU & UAB



Universal Competition Volleyball Nets

Superior quality construction throughout makes this heavy-duty net an ideal companion to any of Porter’s competition volleyball systems. Heavy 4” square netting is provided in black, #60 polyester cord which exceeds specification requirements for all levels of competition. Kevlar Fibercord top cable is available in two lengths. Six, one-inch wide polypropylene tension straps working in conjunction with composite fiberglass dowels hidden in the end pockets provide unmatched appearance and the ultimate in net tension and performance. All nets measure 32’ x 39”.

Sold by top cable length:

Fits All Systems

2295	47’ Universal Net	\$604
2295XL	52’ XL Universal Net	\$640

Universal Kevlar Fibercord Cable

REPL2295	47’ Replacement Top Cable	\$94
REPL2295XL	52’ Replacement Top Cable	\$100



Powr-Sand Outdoor Volleyball Net

The Powr-Sand Outdoor Volleyball net features a tough, durable Kevlar top cable, highly-visible yellow vinyl, and three nylon tensioning straps for a taut fit. Measures 27’10” x 3’3”.

2256	\$280
-------------	--------------

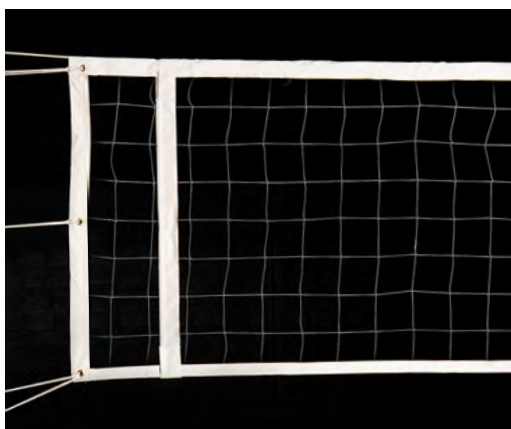

Intramural Volleyball Net

The right choice for physical education and intramural type activities. Heavy black polyester mesh is treated for longer life for either indoor or outdoor usage. Reinforced top binding is provided with a 45’ long black poly rope with 3’ long tie cords to provide net tension.

02254000	\$241
-----------------	--------------





00546000

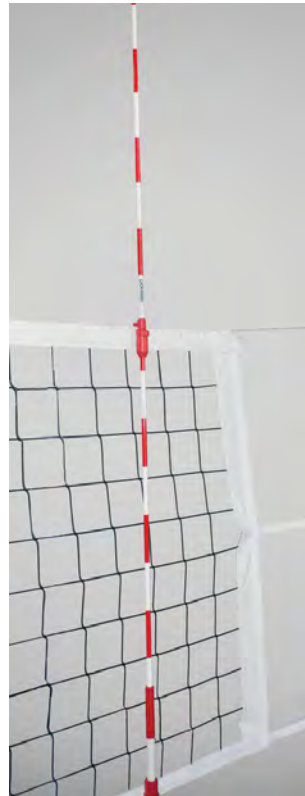

2297

Net Antennas & Boundary Markers

Powr-Select Net antenna assemblies are designed with unique molded plastic clamps with a screw type mechanism for securing to the top and bottom net hems from the floor without the aid of a chair or stepladder, or any tools. 6' single unit construction assures there are no loose parts, which may be disassembled or lost. 3/8" diameter antenna made of high tensile strength, extruded fiberglass material. Meets NFHS, NCAA, FIVB, USAV competition requirements.

Boundary markers are 2" wide durable white woven polyester with hook & loop attachment strips for securing to the net. Boundary marker sleeve holds 3/8" diameter, high tensile strength, fiberglass antenna. 6' long antenna separates into two pieces for compact storage.

- 2297 Powr-Select Net Antenna \$257 (pr)
- 00546000 Boundary Marker w/ Antenna \$194 (pr)



Fair Height Net Chain

Measures the distance from the top of the net tape to the playing surface for a consistent and fair net height. The top hook fastens to the net, and orange markers along the chain represent four competition net height standards: 6'6", 7'-0", 7'4¹/₈", 7'11⁵/₈"

- NETCHAIN \$20



Powr-Select™ Winch

For volleyball facilities who are looking for a dependable net tensioning winch. The Porter Powr-Select Winch is engineered to provide a consistent and smooth operation for the long-term. Compatible with all systems from 3" to 3.5".

- WINH00113 \$570

Replacement Winch Handle Available Online



Sidewinder Net Storage System

Easily wind your volleyball nets on a free standing, transportable rack to keep your nets clean and tangle-free. The storage racks spin easily to neatly grasp and store the headband of the nets as unit glides across the floor on frictionless swivel type casters. Heavy-duty all steel construction has a durable powder-coated finish.

- 00821100 Single (stores 1 net) \$270
- 00823100 Triple (stores 3 nets) \$426

SLEEVES, PLATES & ANCHORS



5"
Chrome Finish



8"
Brass Finish



5" Sleeves and Cover Plates

Choose both finish style and sleeve diameter. Includes both a sleeve and cover plate. Sold individually, not in pairs.

Sleeve with Cover Plate: Chrome Finish

00770100	2 ³ / ₈ "	\$217
00790100	3"	\$229
00870100	3 ¹ / ₂ "	\$249

Sleeve with Cover Plate: Brass Finish

00770200	2 ³ / ₈ "	\$217
00790200	3"	\$229
00870200	3 ¹ / ₂ "	\$249

Replacement 5" Cover Plates

COVR00002000	Chrome	\$148
COVR00034000	Brass	\$153

Replacement 5" Molded Collar

COVR0003200T	\$20
---------------------	-------------

8" Sleeves and Cover Plates

Choose both finish style and sleeve diameter. Includes both a sleeve and cover plate. Sold individually, not in pairs.

Sleeve with Cover Plate: Chrome Finish

00772100	2 ³ / ₈ "	\$246
00792100	3"	\$239
00872100	3 ¹ / ₂ "	\$260

Sleeve with Cover Plate: Brass Finish

00772200	2 ³ / ₈ "	\$246
00792200	3"	\$239
00872200	3 ¹ / ₂ "	\$260

Replacement 8" Cover Plates

COVR00027000	Chrome	\$190
COVR00035000	Brass	\$196

Replacement 8" Molded Collar

COVR0003300T	\$20
---------------------	-------------

Sleeve Adapters

To convert existing sleeves for use with smaller diameter standards. Sold individually, not in pairs.

00827000	Converts 3 ¹ / ₂ " to 2 ³ / ₈ "	\$102
00827300	Converts 3 ¹ / ₂ " to 3"	\$221
00826000	Converts 4" to 3 ¹ / ₂ "	\$223

Second Floor Installation Sleeve

Use in addition to Porter floor sleeves for 2nd floor installations.

00879000	\$451
-----------------	--------------



Wood Floor Anchor

3¹/₂" diameter chrome-plated cover furnished complete with #14 x 1¹/₂" long installation screws.

00242000	\$216 (ea)
-----------------	-------------------



Thin Concrete Anchor

Four double acting expansion anchors provide a pull-out load of 8,200 lbs. Top plate is 3¹/₂" diameter, chrome plated.

00242100	\$200 (ea)
-----------------	-------------------



Grout Type Anchor

Max. 1¹/₄" in total finished floor thickness above concrete sub floor. Anchor installs after finished floor is in place. 1¹/₂" diameter by 3³/₄" length. Chrome anchor top.

00243000	\$290 (ea)
-----------------	-------------------



Sleeper Anchor

Top plate is 3¹/₂" diameter and is threaded to provide adjustment to floor surface.

00244000	\$342 (ea)
-----------------	-------------------



Expansion Anchor

Ideal with at least 6" of concrete. Anchor is 1¹/₂" diameter. Washers may be added or removed to keep surface of anchor flush with floor.

00247100	\$303 (ea)
-----------------	-------------------

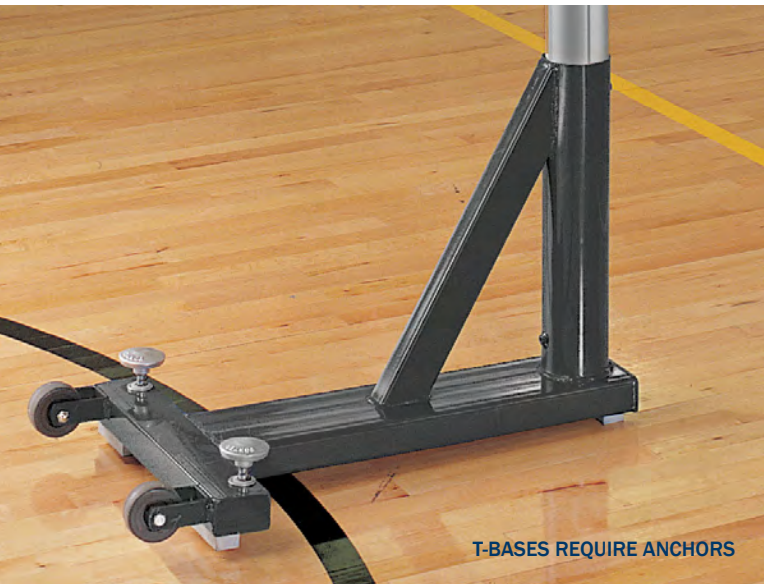

T-BASES REQUIRE ANCHORS

T-Base Standards

The perfect choice for second floor situations when the installation of sleeves is impossible. The compact T-shaped steel base holds 3½” O.D. standards and provides a three-point, tripod type support with an upright sleeve and tubular gusset to eliminate the need for additional cables or bracing. Available option for Powr-Rib II, Powr-Line, Powr-Trak, and Economy standards. Each T-base require two floor anchors.

BASE00102001	T-Base w/ Hand Wheel Kit	\$991 (ea)
HAND00087000	Hand Wheel Kit Only	\$48 (ea)



CUSTOM GRAPHICS
AVAILABLE

CUSTOMIZE IT!
SEE PAGE 19

T-Base Standard Pads

Compatible with Porter’s T-Base volleyball system. Pads enclose standards and base to meet all requirements for competition. Durable polyester reinforced 20oz vinyl with 1½” thick polyethylene filler. Hook and loop fastening system.

8360XX	End Pads	\$1,830 (pr)
8361XX	Center Pad	\$1,185 (ea)

Vinyl Colors: (xx)

01 LIGHT BLUE	02 ROYAL BLUE	03 RED	04 WHITE	05 ORANGE	06 YELLOW GOLD	08 TAN
09 GRAY	10 MAROON	11 PURPLE	12 BLACK	13 NAVY BLUE	14 KELLY GREEN	15 DARK GREEN

T-Base Standards POWR-Rib II

1975	End Standards	\$4,040 (pr)
19759XX	End Standards with Pads	\$5,765 (pr)
1976	Split Collar Center Standard	\$2,430 (ea)
19769XX	Split Collar With Pad	\$3,380 (ea)

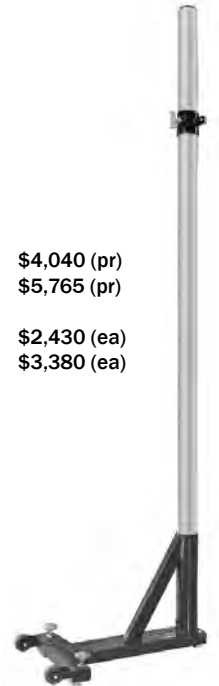

T-Base Standards POWR-Line

1995	End Standards	\$5,090 (pr)
19959XX	End Standards with Pads	\$6,755 (pr)
1996	Center Standard	\$3,640 (ea)
19969XX	Center Standard With Pad	\$4,520 (ea)

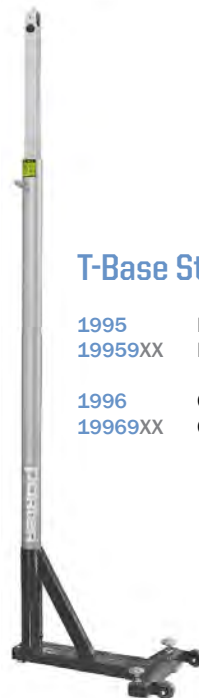

SPORT STANDARDS



Economy Standards

Sturdy, utility construction makes the Economy Standards great for practice courts, cross court setups, and elementary school use. Nets sold separately.

- ✓ Powder Coated Steel Standards
- ✓ Winch Includes A Nylon Tension Strap For Installing And Fine Tuning Your Volleyball Net
- ✓ Net Heights Are Quickly And Easily Adjustable For Competition Settings Using A Sliding Collar And Spring Loaded Pin

End Standards

851	3½" Diameter	\$2,095 (pr)
8519XX	3½" Diameter with Official Pads	\$2,885 (pr)



Ultimate Outdoor Volleyball Standards

High strength 4" square anodized aluminum posts for outdoor use. Groove in winch post permits easy and infinite net height settings including badminton and tennis. Heavy duty net tensioning reel with removable handle included. Net, post pads, and ground sleeves sold separately.

Anodized sleeves with removable zinc cover plate for secure installation. 2'4" sleeve for ground installation, 3'4" extended sleeve for sand installation. The post extension anchor kit allows for installation on sand court without concrete footings. Kit includes a pair of 4' long powder coated steel post extenders. 2' x 6' lumber spreaders required for stabilizing but not included.

Protective pads are 6' tall and attach with weather resistant cord lacing. 1½" foam covered in rugged 20oz vinyl available in 14 colors.

591	Standards	\$1,805 (pr)
00444000	Ground Sleeve	\$340 (ea)
00444040	Extended Sand Ground Sleeve	\$309 (ea)
592	Post Extension Anchor Kit	\$295 (pr)
2256	Outdoor Net	\$280 (ea)
5930XX	Post Pads	\$633 (pr)

Vinyl Colors: (xx)

01 LIGHT BLUE	02 ROYAL BLUE	03 RED	04 WHITE	05 ORANGE	06 YELLOW GOLD	08 TAN
09 GRAY	10 MAROON	11 PURPLE	12 BLACK	13 NAVY BLUE	14 KELLY GREEN	15 DARK GREEN

STORAGE & TRANSPORT



825



825 with
82501 Add-On

Wall Storage Rack

Securely store two volleyball standards vertically in a compact space. Each upright is held in place with a hook-and-loop fastening tape. Wall mounting hardware included. Optional lock sold separately.

825 \$161

Storage Rack Lock

Add this locking front gate mechanism to your existing 825 wall storage rack or purchase both to create a secure storage place for two standards. Includes lock, easy to install.

82501 \$175

Powr Volleyball Transport System

Convenient, specially designed heavy-duty transport system is equipped to store three full competition volleyball courts complete with standards, protective pads, nets, judge's stand and balls. Rolls easily from gym to storage room on 3½" diameter swivel casters.

00956100 \$837



Standard Transporter

Steel boot with non-marking wheels slides easily onto the end of any standard which is then easily rolled to the storage location.

9564 \$147



RECREATION STANDARDS



Tetherball

Galvanized 2³/₈" post suitable for indoor or outdoor use. Official 10' height with extended post option for 2' deeper installation when required. Floor sleeves and outdoor ground sleeve sold separately.

00763200	Post with Tetherball	\$330
00763600	Extended Post with Tetherball	\$410
00763000	Post Only	\$279
00763100	Tetherball Only	\$31
00402000	Outdoor Ground Sleeve	\$224
BASE00006	Portable Base Only	\$609



Weighted Base Game Standards

Tip and roll weighted base system requires no installation! Powder coated 2³/₈" steel standard with eye bolts and eye nuts for net attachment at men's volleyball, women's volleyball or badminton heights. 24" diameter domed steel base weighs approximately 145lb and is encased in black, non marking rubber to prevent sliding and floor damage. 3" diameter non marking casters for easy transport.

00431000	Volleyball/Badminton Standards w/ Base	\$1,635 (pr)
00431100	Volleyball/Badminton Center Standard w/ Base	\$827 (ea)
BASE00006	Portable Base Only (No Upright)	\$609 (ea)
02254000	Intramural Volleyball Net	\$241 (ea)
2236110	Badminton Net	\$111 (ea)





Pickleball Net

21' x 35" pickleball net exceeds specification for all levels of competition. Black 1³/₄" square netting is a #60 polyester cord with a Kevlar Fibercord top cable and UV-treated vinyl top pocket, offering superior Porter performance during events and tournaments.

2210 **\$297**

Pickleball Competition Standards

Galvanized 3¹/₂" diameter black powder coated steel posts engineered to competition specification. Winch post incorporates internal winch system with removable, external handle and is paired with a tie-off post. Net top cable attachment is internal beneath removable top caps. Indoor/outdoor sleeves sold separately.

4540	3 ¹ / ₂ " Diameter Standards	\$520 (pr)
00403000	Outdoor Ground Sleeve	\$174 (ea)
Page 24	Indoor Floor Sleeves	

Badminton Standards

Durable 2³/₈" diameter, powder coated steel tube uprights suitable for both indoor and outdoor use. Standards fitted with cast iron pulley to reduce cable drag on net. Rope cleats secure net rope for proper tension at badminton or pickleball heights.

Portable version available with T-shaped steel bases with non marking rubber feet for stability without use of floor anchors. Each 145lb base has two 3" diameter casters

Net and floor/outdoor sleeves sold separately.

764100	Sleeved End Standards	\$563 (pr)
764150	Sleeved Center Standard	\$285 (ea)
779000	Portable End Standards	\$3,005 (pr)
00827000	3 ¹ / ₂ " to 2 ³ / ₈ " Sleeve Adapter	\$102 (ea)
00402000	2 ³ / ₈ " Outdoor Ground Sleeve	\$224 (ea)

Badminton Net

20' x 30" net made of #6 black treated cotton with 1" square mesh. Net tie off cords with sufficient length for use on volleyball standards with 36" centers. May also be used for pickleball.

2236110 **\$111**



TRAINING

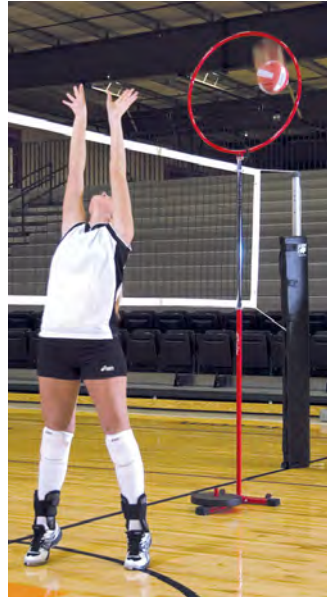

Target Challenger

Adjustable pole height and 30" target ring allow for multi-purpose target training. Ideal for passing, shooting, and setting drills. Net collects balls for easy retrieval.

TA375 \$504



Blocking Hands

With Porter's Blocking Hands, athletes have the opportunity to expand their reach, achieving success through the use of this training aide. Blockers have the chance to experience the feeling of a "clean" block.

8565 \$67 (pr)



Net Trainer

Define zones for your players to attack, set, or defend. Colored vinyl net sleeve easily attaches with hook-and-loop closure. Features 9 colored zones.

NETSLVE0029 \$403



Speed Rope

Stainless steel cable encased in plastic for maximum speed.

TA128	9' Rope	\$30
TA1281	10' Rope	\$33



Agility Dots

Set of 6 brightly colored dots for agility training.

TA1694	\$57
--------	------



Spot Target Training

Supply athletes with hitting targets or position locations. Includes 6 multicolored non-slip 17" dots.

TA378	\$76
-------	------



Tabletop Flip Scoreboard

Collapsible Scoreboard displays points 0-30 for two teams. An additional tally 0-9 is included to keep track of time outs or games within a match.

830901	\$75
--------	------



PowerMax® Medicine Ball V2

14" Diameter impact absorbing ball with textured grip.

TA1362	6 lb Ball	\$149
TA1364	10 lb Ball	\$168
TA1367	16 lb Ball	\$199
TA1369	20 lb Ball	\$220



PowerMax® Swing Ball

Rubber ball with 1/3" nylon rope handle. 30" from stopper to rope end.

TA1332	2K Ball	\$121
TA1333	3K Ball	\$144
TA1334	4K Ball	\$169
TA1335	5K Ball	\$199

TRAINING



The PowerMax® Vertical Jump Trainer

The PowerMax® Vertical Jump Trainer is constructed of aluminum, providing a lightweight, reliable solution for any vertical training needs. Tip and Roll wheels provide easy transportation while the rubber adjustable feet offer a secure base that won't mar your floor. Foldable Weight Arms on both ends of the base allow for weights to be added for more stability. Colored vanes provide quick and easy measurement readings. Height ranges from 95" to a maximum height of 146"

TA205 \$761



PowerMax® Soft Plyoboxes

Less intimidating than standard metal or wood plyoboxes. Lightweight, yet durable construction. Boxes stack with industrial strength Velcro®.

TA203	3" Box	\$203
TA206	6" Box	\$275
TA212	12" Box	\$394
TA218	18" Box	\$551
TA224	24" Box	\$672

TA225 Package \$2,030

Package Includes: 5 Plyoboxes, 1 Each Size



Volleyball Ball Cart

Tubular steel frame with swivel casters that fold for storage. Standard cart stores up to 24 volleyballs. 51"W x 22"D x 39"H.

9562 Standard Ball Cart \$214

POWR SERIES

SIX POWERFUL SYSTEMS

Decide which is best for your team.

POWR-CARBON™ II

Material	Carbon Fiber
Height Adjustment	Telescoping Upright
Sports Supported	Volleyball
Competition Level	College, High School, Club, Junior High
Available Posts	3"

POWR-HYBRID™

Material	Carbon Fiber + Aluminum
Height Adjustment	Telescoping Upright
Sports Supported	Volleyball
Competition Level	College, High School, Club, Junior High
Available Posts	3"

POWR-LINE™

Material	Aluminum
Height Adjustment	Telescoping Upright
Sports Supported	Volleyball
Competition Level	College, High School, Club, Junior High
Available Posts	3", 3.5", T-Base

POWR-STEEL™

Material	Steel
Height Adjustment	Telescoping Upright
Sports Supported	Volleyball
Competition Level	College, High School, Club, Junior High
Available Posts	3"

POWR-RIB™ II

Material	Aluminum
Height Adjustment	Collar with Pressure Lock T-Handle
Sports Supported	Volleyball, Tennis, Pickleball, Badminton
Competition Level	High School, Club, Junior High, Parks and Recreation Facilities
Available Posts	3", 3.5", T-Base

POWR-COURT™ PRO



- Game Ready Portable - no anchors needed
- Turns any hard surface into a volleyball court
- Quick and easy setup
- System includes: standards, built-in judge's stand, net, and antennas

portier®

*THE POWR
OF PORTABILITY*

porter

PORTERATHLETIC.COM | 888.277.7778
601 MERCURY DRIVE | CHAMPAIGN, IL. 61822



PRESORTED STD
U.S. Postage
PAID
LITANIA SPORTS
GROUP

2026 VOLLEYBALL

EQUIPMENT COLLECTION



STANDARDS | PADS | JUDGE'S STANDS | NETS

PORTERATHLETIC.COM

888.277.7778

601 MERCURY DRIVE | CHAMPAIGN, IL 61822

SALES@PORTERATHLETIC.COM